



Republic of the Philippines
Department of Education
 NATIONAL CAPITAL REGION

CN-2023-78-7-8513

August 9, 2023

REGIONAL MEMORANDUM

No. 752, s. 2023

To: Chiefs, Functional Divisions
 Schools Division Superintendents
 Division Budget Officers
 Programs Implementers
 All Others Concerned

**GUIDELINES ON THE UTILIZATION AND REPORTING OF THE FY 2023
 DISASTER PREPAREDNESS AND RESPONSE PROGRAM (DPRP) FUNDS**

1. Attached herewith are the advisory and Implementing guidelines on the Utilization and DPRP Funds from Usec. Annalyn M. Sevilla, Undersecretary for Finance.
2. All Officers concerned are directed to implement efficient and effective management and utilization of allocated budget and cash resources and ensure the timely execution to provide real-time updates on the status of PAPs to maximize the utilization of the agency's budget.

WILFREDO E. CABRAL, CESO III
 Regional Director

Encl.: As stated



Misamis St., Bago Bantay, Quezon City
 Email Address: ncr@deped.gov.ph
 Website: <http://www.depedncr.com.ph>

Doc. Ref. Code	RO-ORD-F004	Rev	00
Effectivity	01.26.23	Page	1 of 1



ADVISORY

August 04, 2023

FOR :

- All Regional Directors**
- All Schools Division Superintendents**
- All Regional and Division Budget Officers**
- All Regional and Division DRRM Coordinators**

The Disaster Risk Reduction and Management Service (DRRMS) hereby furnishes the attached **Sub-Allotment Release Order (Sub-ARO) for Disaster Preparedness-related Programs, Projects, and Activities (PPAs) and Response Interventions** to all Regional Offices (ROs) and Schools Division Offices (SDOs) under the Fiscal Year 2023 Disaster Preparedness and Response Program (DPRP) Funds.

In relation thereto, the general and implementing guidelines was already released on 02 August 2023. With this, the Regional Budget Officers are hereby instructed to facilitate the immediate processing and downloading of funds for Disaster Preparedness-related PPAs to all SDOs to fund the implementation of their planned activities following the allocations in the enclosures below:

- **Enclosure 2:** *Breakdown of FY 2023 Disaster Preparedness and Response Program;*
- **Enclosure 6:** *FY 2023 DPRP Allocation of Funds for Regions and Divisions for the Enhancement and/or Development of Contingency Plans in DepEd Field Office and Schools; and*
- **Enclosure 7:** *FY 2023 DPRP-Allocation of Funds for Regions and Divisions for the Enhancement and/or Development of Public Service Continuity Plan*

Meanwhile, the funds for the Response Interventions are lodged to the ROs which will serve as Regional Standby Funds. The release of funds to SDOs will be prompted by the prescribed provisions for the use of Regional Standby Funds under the Implementing Guidelines.

Regional and Division DRRM Coordinators are advised to implement their proposed PPAs based on the approved Work and Financial Plan (WFP) funded under the Disaster Preparedness and Response Program (DPRP) Funds. For field offices with procurement activities calendared for this Fiscal Year 2023, they are advised to proceed with the usual process of procurement short of award while waiting for the Sub-ARO to be released by your respective Regional Budget Officers.

For clarifications and concerns, please do not hesitate to reach out to the DRRMS through email at drmo@deped.gov.ph or landline at (028) 637-4933.

For information and appropriate action.

ATTY. CHRISTIAN E. RIVERO, EdD
Director IV, DRRMS



Republic of the Philippines
Department of Education
OPERATIONS

OUOPS No. 2023-04- 6762
MEMORANDUM

For : **Regional Directors**
Schools Division Superintendents
Regional and Division Budget Officers
Regional and Division DRRM Coordinators

FROM : 
ANNALYN M. SEVILLA
Undersecretary for Finance

ATTY. REVSEE A. ESCOBEDO
Undersecretary for Operations

Subject : **GUIDELINES ON THE UTILIZATION AND REPORTING OF
THE FY 2023 DISASTER PREPAREDNESS AND RESPONSE
PROGRAM (DPRP) FUNDS**

DATE : July 25, 2023

PURPOSE

The purpose of these guidelines is to provide guidance on the utilization of the Fiscal Year 2023 (FY 2023) Disaster Preparedness and Response Program (DPRP) funds managed by the Disaster Risk Reduction and Management Service (DRRMS).

These guidelines will ensure that expenses are monitored in accordance with authorized provisions, and that fund utilization is synchronized with the overall plans, targets, and schedules of implementing units.

GENERAL GUIDELINES

The Regional Offices (ROs) and Schools Division Offices (SDOs) must utilize their respective allocations of FY 2023 DPRP funds efficiently and effectively for the implementation and monitoring of Disaster Preparedness-related Programs, Projects, and Activities and Response Interventions as indicated in **Enclosure 1a: Summary of Allocation for Regional Offices for Disaster Preparedness-related PPAs** and **Enclosure 1b: Summary of Allocation for Regional Offices for Response Interventions**.

DRRMS_CDP/07242023

Ground Floor, Rizal Building, DepEd Complex, Meralco Avenue Pasig City 1600
Email: oure@deped.gov.ph; Website: www.deped.gov.ph
Tel. No.: (02) 8633-5313; (02) 8631-8492

It is important to note that these funds should not be used for any Climate Change Adaptation and Mitigation (CCAM) PPAs unless otherwise indicated in a supplemental memorandum aligned with this Implementing Guidelines.

GENERAL OBJECTIVE

This FY 2023 DPRP funds is intended for Implementing Units (IUs) to implement and monitor Disaster Preparedness-related PPAs and Response Interventions under the Disaster Risk Reduction and Management Service (DRRMS).

COVERAGE

The DRRMS will provide fund support from the approved FY 2023 DPRP funds for the implementation of the Disaster Preparedness-related PPAs, and Response Interventions in all Regions and Divisions of the Department of Education (DepEd), except for the Bangsamoro Autonomous Region for Muslim Mindanao (BARMM).

The said funds will also be provided to field offices with schools affected by the previous disasters and/or emergencies. These schools must be included in the vetted RADaR and/or Incident Report. The said recipients shall only cover those affected schools with unfunded allocation of TLS for the last 2-years upon issuance of this guideline.

The FY 2023 DPRP funds appropriations will remain valid until December 31, 2024.

PROCUREMENT

The Regional and Division DRRM Coordinators are required to ensure that the funds are utilized judiciously, in compliance with the existing accounting and auditing rules and regulations, as well as the procurement guidelines set forth by **Republic Act (RA) 9184**, also known as *an Act Providing for the Modernization, Standardization and Regulation of the Procurement Activities of the Government and for Other Purposes* and its *Implementing Rules and Regulations as amended*. This will help standardize the procurement process, promote transparency, accountability, equity, efficiency, and economy in government offices, and prevent confusion.

As part of the strategy to effectively communicate the flagship program of the Department, the logos of DepEd, MATATAG, and DRRMS shall be used and reflected in all procured items. The **DO No. 31, s. 2019** titled *The Department of Education Service Marks and Visual Identity Manual* and **PAS-OD-2023-006** titled *MATATAG Branding Guidelines and Templates* are provided as references to ensure consistency and adherence to the provision in the usage of the logos.

REGIONAL STANDBY FUNDS

The approved **Two Billion Pesos** (*Php 2,000,000,000.00*) of the FY 2023 Disaster Preparedness and Response Program funds will be used for the implementation of Disaster Preparedness-related PPAs and Response Interventions for field offices. Of this amount, a total of **One Billion Seven Hundred Ninety-Seven Million One Hundred Twenty-Six Thousand Eight Hundred Pesos** (*Php 1,797,126,800.00*)

AS

will be prepositioned to the Regional offices as indicated in **Enclosure 1c: Summary of FY 2023 Disaster Preparedness and Response Program Funds Downloaded to Field Offices**

The Disaster Response fund (Enclosure 1b) lodged at the Regional office will serve as the Regional Standby fund. The downloading of the fund to the Schools Division Offices (SDOs) will be triggered by the following minimum provisions:

Use of the Standby Funds:

1. Standby fund shall be provided to the SDOs during the declaration of a State of Calamity, or State of Emergency by the Local Government Units (LGUs) or National Government, or other disaster-related declaration (whether naturally occurring or human-induced) that is deemed necessary.
2. On the other hand, when there is no State of Calamity or State of Emergency, and there is a need to use the standby fund, there should be an authority to request the utilization of the fund:
 - a. Regional Director and the concerned Schools Division Superintendent will request to use the regional standby funds and provide necessary Justification through a Memorandum.
 - b. Director IV of the DRRMS will evaluate the submitted Memorandum from the Regional Director and the concerned Schools Division Superintendent and provide corresponding recommendations.
 - c. The request and justification shall be approved by the Undersecretaries for Finance and Operations.
 - d. Finally, the DRRMS will issue a memorandum to the Regions notifying them of the decision.
3. In cases where no disaster occurs in the Regions toward the end of 4th quarter, the DepEd Central Office may withdraw the standby fund and download it to the Regional Offices that need it most.

UTILIZATION OF ALLOTMENT ISSUED:

Pursuant to the Department of Budget and Management (DBM) National Budget Circular (NBC) No. 590 dated January 03, 2023, these guidelines are established to direct the utilization of FY 2023 DPRP funds and to monitor expenses in accordance with authorized general and specific provisions.

A total of Two Billion Pesos (*Php 2,000,000,000.00*) has been allotted for Disaster Preparedness and Response Program and will be downloaded to field offices as per DBM Circular. Regional offices are required to prepare Sub-Allotment Release Orders (Sub-ARO) to their respective Schools Division Offices (SDOs) based on the allocation presented in **Enclosures 1a** and **1b**.

For consistency, the guidelines provided by **DBM Circular No. 2007-1** (*Guidelines on the Grant of Honoraria to Lecturers, Resource Persons, Coordinators, and Facilitators*) and **Executive Order No. 77, s. 2019** (*Prescribing Rules and*

MS

Regulations and Rates of Expenses and Allowances for Official Local and Foreign Travels of Government Personnel) must be strictly followed.

These guidelines are intended to provide Regions and Divisions with the necessary information to efficiently and effectively utilize the funds for their intended purpose, ensuring compliance with the authorized provisions.

MONITORING AND REPORTING:

To monitor the progress of the implementation of the Disaster Prepared-related PPAs and Response Interventions, implementing units are required to submit a monthly report to the DRRMS at drmo@deped.gov.ph on or before the end of the month. These reports should include information on the accomplishments, obligations, liquidation status, and photo documentation of the utilization of the FY 2023 DPRP. Templates for these reports will be provided and may be accessed through bit.ly/FY_2023_DPRP_Reporting.

Further, the Regional Office shall observe the process flow for the monitoring and reporting:

1. The Regional Office shall regularly monitor and remind SDOs of the submission of their status reports.
2. The Regional Office shall collect and consolidate the submitted monthly report from the SDOs.
3. The monthly consolidated report shall be submitted to the Office of the Director IV, DRRMS on or before the **first week of the succeeding month**.
4. The DRRMS shall consolidate all Regional submissions and shall furnish copies to the EXECOM

The DRRMS of the DepEd Central Office is authorized to conduct monitoring on the utilization of the funds downloaded to field offices chargeable against the approved FY 2023 DPRP fund. This is to ensure that the fund will be used according to its purpose.

For more information, queries, and concerns, please contact DRRMS at telephone number (02) 8637-4933, (02) 8635-3764 or through email at drmo@deped.gov.ph.

For immediate dissemination and strict compliance.

ANNEX A: IMPLEMENTING GUIDELINES ON THE USE OF THE FY 2023 DISASTER PREPAREDNESS AND RESPONSE PROGRAM FUNDS FOR DISASTER RISK REDUCTION AND MANAGEMENT (DRRM) PROGRAMS, PROJECTS, AND ACTIVITIES (PPAs)

The FY 2023 Disaster Preparedness and Response Program (DPRP) fund is available to support the implementation of Disaster Risk Reduction and Management (DRRM) priority Programs, Projects, and Activities (PPAs) of the Implementing Units.

1. The following activities are eligible for funding under this component of the FY 2023 DPRP:
 - a. Conduct of Regional and Division DRRM Coordination Meetings;
 - b. Monitoring and evaluation visits for DRRM PPAs;
 - c. Capacity building on DRRM PPAs for skill-enhancement of DRRM Coordinators;
 - d. Development and distribution of DRRM advocacy materials (e.g., video, print, radio, television);
 - e. Conduct of Nationwide Simultaneous Earthquake Drill (NSED), based on **DepEd Order No. 53, s. 2022: Mandatory Unannounced Earthquake and Fire Drills in School**, and other multi-hazard drills **DepEd Order No. 33, s. 2021: School-Based Disaster Preparedness and Response Measures for Tropical Cyclones, Flooding, and Other Weather-Related Disturbances and Calamities**);
 - f. Monitoring and Submission of RADaR of School Disaster Risk Reduction and Management Coordinators; and
 - g. Procurement of disaster preparedness and response-related PPAs and Response Interventions.

2. Only the following expenses are allowed under this component of the FY 2023 DPRP:
 - a. Travel expenses necessary for conduct of DRRM PPAs, such as face-to-face workshops, capacity building training, monitoring and evaluation, and school visits;
 - b. Board and lodging of participants and management team, use of function rooms, and other equipment for face-to-face activities, subject to the guidelines as stipulated in **DepEd Order No. 02, s. 2018: Guidelines on the allocation of funds for venue, meals, and snacks, and room accommodation of official activities organized and conducted by the Department of Education (DepEd)**;
 - c. Honorarium of resource speakers based on the guidelines as mentioned in the **Department of Budget and Management (DBM) through Circular No. 2007-01** titled *Guidelines on the Grant of Honoraria to Lecturers, Resource Persons, Coordinators, and Facilitators*;
 - d. Payment of supplies and materials necessary for the conduct of workshops/trainings;
 - e. Payment for the production and delivery of the DRRM advocacy materials;

- f. Payment for the procurement and delivery of disaster preparedness-related PPAs and Response Interventions;
 - g. Payment of registration fees for DRRM-related local training for plantilla-DRRM Coordinators for Regional and Schools Division Offices;
 - h. Payment of One-time load expenses of the School Disaster Risk Reduction and Management Coordinator in the amount of **One Thousand Pesos (Php 1,000.00)** for one School Year; and
 - i. Renewal of radio licenses for hand-held and base radio equipment.
3. The allocated funds shall not be allowed to be used for the following:
 - a. Payment of salaries and overtime of Job Orders, Casual and Contract of Service (CoS) staff;
 - b. Purchase of equipment that may fall under Capital Outlay; and
 - c. All other expenses which are not mentioned above.
4. Region and Schools Division Offices fund allocation for FY 2023 is provided in **Enclosure 2: Breakdown of FY 2023 Disaster Preparedness and Response Program funds: Implementation of Disaster Risk Reduction and Management (DRRM) Programs, Projects, and Activities.**
5. The Regional and Division DRRM Coordinators shall furnish copies of their approved Expenditure Matrix to the DRRMS using **Enclosure 3: FY 2023 Disaster Preparedness and Response Program-Expenditure Matrix for Disaster Preparedness-related PPAs and Response Interventions.**
6. The Regional and Division DRRM Coordinators shall provide photo documentation using **Enclosure 4: FY 2023 Disaster Preparedness and Response Program: Photo Documentation on the Conduct of Disaster Preparedness-related PPAs, and Response Interventions.**
7. Regional and Division DRRM Coordinators shall submit the status of program implementation and fund utilization on a quarterly basis using **Enclosure 5: Quarterly Status of the FY 2023 Disaster Preparedness and Response Program Funds on the Implementation of Disaster Preparedness-related PPAs and Response Interventions.**
8. All forms must be prepared by the DRRM Coordinator, reviewed by the Budget Officer, and approved by the Regional Director for the Regional Office or the Schools Division Superintendent for the Division Office. All approved forms/reports shall be submitted to the DRRMS on or before the last week of every quarter.

K

9. The report must be addressed to the Director IV of the DRRMS using the email: drmo@deped.gov.ph with the subject: DPRP[PSF2023] Region/Division | Report (e.g., DPRP[PSF2023] Region III Report; DPRP[PSF2023] Region III SDO Pampanga Report).

APPROVED:

ANNALYN M. SEVILLA
Undersecretary for Finance

ATTY. REVSEE A. ESCOBEDO
Undersecretary for Operations

ANNEX B: IMPLEMENTING GUIDELINES OF THE FY 2023 DISASTER PREPAREDNESS AND RESPONSE PROGRAM FUNDS FOR THE DEVELOPMENT AND/OR ENHANCEMENT OF CONTINGENCY PLANS (CP) IN DEPED FIELD OFFICES AND SCHOOLS

The Department of Education (DepEd) conducts an annual contingency planning to ensure effective preparation and response to disasters and/or emergencies. This is crucial in addressing the vulnerabilities of the education sector and ensuring the continuous delivery of equitable education amidst natural and human-induced hazards.

1. To support this initiative, the DepEd Disaster Risk Reduction and Management Service (DRRMS) provides funds for the following activities:
 - **Regional office-level writeshop** to develop or enhance existing regional office contingency plans;
 - **Division office-level writeshop** to develop or enhance existing division office contingency plans;
 - **School-level training** on Contingency Planning; and
 - **School-level writeshop** to develop and/or enhance existing school contingency plans.

The region and division fund allocations for Contingency Planning are provided in **Enclosure 6: FY 2023 Disaster Preparedness and Response Program-Allocation of Funds for Regions and Divisions for the Development and/or Enhancement of Contingency Plans in DepEd Field Office and Schools.**

In addition, this fund can also be used to supplement the FY 2023 Comprehensively Released Funds to Regions for the Development and/or Enhancement of Contingency Plans.

2. The downloaded funds for the conduct of office-level writeshop on the development and/or enhancement of existing office contingency plan shall cover **20 office personnel**, representing each section/unit, along with one (1) personnel to act as secretariat and one (1) member of the Quality Assurance & Monitoring and Evaluation Team, and one (1) resource person.
 - a. Each unit/section from the Regional Office (RO) or Schools Division Office (SDO), must be represented in the Contingency Planning writeshop. This includes representatives from the office of the Schools Division Superintendent (SDS) or Assistant Schools Division Superintendent (ASDS), and office of the Regional Director (RD) or Assistant Regional Director (ARD).
 - b. The personnel who will be a member of the Quality Assurance & Monitoring and Evaluation Team should come from Human Resource Development Division (HRDD) of the region or the assigned focal person in the division and must be separate from personnel considered as participants in the writeshop.
3. The downloaded funds to the divisions for the conduct of school-level training on Contingency Planning shall cover all schools represented by the School Head or School DRRM Coordinator. In addition, 5 to 10 personnel



will act as secretariat and members of the Quality Assurance & Monitoring and Evaluation Team, while 1 to 12 resource persons will be present depending on the number of participants.

4. The downloaded funds for the conduct of the office-level writeshop and school-level training on Contingency Planning shall be used to cover the following expenses:
 - *Venue of office-level writeshop and school-level training;*
 - *Board and lodging of the participants, secretariat and resource persons (live-in participants);*
 - *Meals of participants (live-out participants)*
 - *Honorarium for resource persons based on the existing guidelines set by the Department of Budget and Management (DBM); and*
 - *Reproduction of materials and kits.*
 - a. The regions or divisions may opt to conduct a live-out office-level writeshop in the regional or division conference rooms and reallocate the funds intended for venue and board and lodging if there's a need to cater additional participants beyond the prescribed 20 personnel from the region or division offices.
 - b. However, any transportation expenses incurred for this event will be charged against the local funds, subject to existing accounting, and auditing rules and regulations.
5. The funds for the school-level writeshop on the development and/or enhancement of existing school contingency plan may be downloaded to all schools, in consideration of the following:
 - a. The school-level writeshop shall include at least six (6) participants, including the School Heads, School DRRM Coordinators, and other members of the School DRRM Team.
 - b. Each participant of the school-level writeshop is allotted Php 1,000.00 to cover morning and afternoon snacks, lunch, and workshop materials.
 - c. The schools may involve additional participants for the school-level writeshop but expenses shall not exceed the allotted Php 6,000.00.
 - d. For small schools and/or clustered schools with the same School Heads and with less than six (6) personnel, the divisions are given the prerogative to explore ways in conducting the school-level writeshop such as but not limited to organizing a 1-day INSET session.
6. To ensure consistency in all Contingency Plans, it is recommended that DepEd field offices and schools use the provided Contingency Planning templates and Contingency Planning Guidebook. These resources can be accessed through: **<https://bit.ly/DepEdConPlanReferences>**.
7. The Region and Division DRRM Coordinators must submit a copy of their office's developed and/or enhanced Contingency Plans to DRRMS at drmo@deped.gov.ph within **ten (10) working days after the conduct of the Writeshop** with the subject: DPRP[ConPlan2023] Region/Division

| Report (e.g., DPRP[ConPlan2023] Region III Report; DPRP[ConPlan2023] Region III SDO Pampanga Report).

8. The Division DRRM Coordinators are responsible for consolidating and submitting copies of developed and/or enhanced school-level Contingency Plans to DRRMS at drmo@deped.gov.ph once all schools in their division have already completed their Contingency Plan writeshop.
9. To document and monitor this activity, Regional and Division Budget Officers should work with the Regional and Division DRRM Coordinators and refer to the General Guidelines on the reporting and submission of fund utilization.

APPROVED:

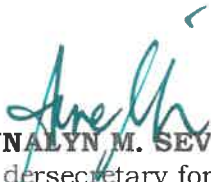

ANNALYN M. SEVILLA
Undersecretary for Finance

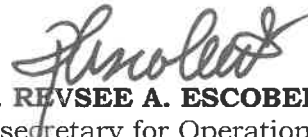

ATTY. REVSEE A. ESCOBEDO
Undersecretary for Operations

ANNEX C: IMPLEMENTING GUIDELINES OF THE FY 2023 DISASTER PREPAREDNESS AND RESPONSE PROGRAM FUNDS FOR THE DEVELOPMENT AND/OR ENHANCEMENT OF PUBLIC SERVICE CONTINUITY PLAN (PSCP)

The development of a Public Service Continuity Plan (PSCP) is a critical component of organizational management that involves preparing for and responding to potential disruptions in the delivery of public services. The plan is intended to help the government function and provide essential services continuously, particularly during disasters and emergencies.

Having a PSCP at the Central, Region, and Schools Divisions offices of the Department ensures the continuity and equitable access to educational services, even during disasters and emergencies.

1. The DepEd Disaster Risk Reduction and Management Service (DRRMS) shall provide funds for the following activity:
 - **Regional office-level training and writeshop** on the development of and enhancement of existing PSCP of the regional offices; and
 - **Division office-level training and writeshop** on the development of and enhancement of existing PSCP of the division offices.

Specific allocation per office is provided in **Enclosure 7: FY 2023 Disaster Preparedness and Response Program-Allocation of Funds for Regions and Divisions for the Development and/or Enhancement of Public Service Continuity Plan.**

Additionally, this fund will be used to supplement the *Comprehensively Released Funds to Regions for the Development and/or Enhancement of Public Service Continuity Plan* that was released earlier this year.

2. The downloaded funds shall cover the participation of **25 personnel from concerned units/sections, as well as 3 personnel to act as secretariat or members of the Quality Assurance & Monitoring and Evaluation team, and 2 resource persons** for the 4-day training and workshop.
 - a. Each unit/section from DepEd field office is represented in the PSCP Training and Writeshop, including representatives from the office of SDS/ASDS and the office of RD/ARD.
 - b. The three personnel who will act as secretariat or members of the Quality Assurance & Monitoring and Evaluation Team should come from Human Resource Development Division (HRDD) of the region or the assigned focal person in the division and must not be included in the 25 participants in the training and writeshop event.
3. The downloaded funds shall be utilized for the following expenses:
 - *Venue of the training and workshop;*
 - *Board and lodging of the participants, secretariat/Quality Assurance & Monitoring and Evaluation team, and resource persons (live-in arrangement);*
 - *Meals for participants, secretariat, and resource persons (live-out arrangement);*

- *Honorarium for resource persons based on the existing guidelines set by the Department of Budget and Management (DBM); and*
 - *Reproduction of materials and kits.*
- a. The regions and divisions may opt to conduct a live-out office-level writeshop in the regional or division conference rooms and reallocate the funds intended for venue and board and lodging, if there's a need to cater additional participants beyond the prescribed 25 personnel from the region or division offices.
 - b. However, any transportation expenses incurred for this event will be charged against the local funds, subject to existing budgeting, accounting, and auditing rules and regulations.
4. After the training and writeshop on the development and enhancement of PSCP, the Regional and Division DRRM Coordinators must submit a copy of the developed and/or enhanced PSCPs to DRRMS at drmo@deped.gov.ph within two weeks after the conduct of the training and writeshop. The PSCP guidebook can be accessed through **<https://bit.ly/DepEdPSCPReferences>**.
 5. To ensure proper documentation and monitoring of this activity, the Regional and Division Budget Officers, in coordination with the Regional and Division DRRM Coordinators, should refer to the General Guidelines on the reporting and submission of fund utilization.

APPROVED:

ANNALYN M. SEVILLA
 Undersecretary for Finance

ATTY. REVSEE A. ESCOBEDO
 Undersecretary for Operations

ANNEX D: IMPLEMENTING GUIDELINES OF THE FY 2023 DISASTER PREPAREDNESS AND RESPONSE PROGRAM FUNDS FOR THE PROCUREMENT OF SAFETY AND EMERGENCY SUPPLIES AND EQUIPMENT FOR SCHOOLS

1. In the interest of empowering the Department of Education (DepEd) learners and personnel in securing their lives and safety, ensuring learning continuity in times of disasters and/or emergencies, and to strengthen the resilience of basic education in the context of natural and human-induced hazards, the Disaster Risk Reduction and Management Service (DRRMS) provides safety and emergency supplies and equipment to pre-identified One Thousand Nine Hundred Eighty-Eight (1,988) schools listed in **Enclosure 8: List of School Beneficiaries of the Safety and Emergency Supplies and Equipment**
2. The prioritization and selection of the 1,988 schools was based on the following criteria:
 - a. Schools with critical hazard exposure and vulnerability recorded for the last twelve (12) years based on the analysis of the consolidated hazard exposure data from Enhanced Basic Education Information Systems (EBEIS) SY 2009-2010 through SY 2020-2021; and
 - b. Available funds from DepEd DRRMS for this activity.
3. The downloaded funds shall be utilized for the **Procurement of Safety and Emergency Supplies and Equipment** for the identified schools. Each beneficiary school shall be allocated an amount of Ninety-Six Thousand Seven Hundred Pesos (P96,700.00).
4. The downloaded funds shall be utilized to procure the safety and emergency supplies and equipment in the following table:

No.	Item	Quantity	Unit of Measure	Unit Cost	Total Cost
1	Portable Public Address system	1	Piece	11,500.00	11,500.00
2	Trauma Bag with contents for 20 - 25 persons	2	Piece	15,000.00	30,000.00
3	Fire Extinguisher	2	Piece	1,300.00	2,600.00
4	Fire Cabinet and Fire Hose	2	Piece	7,800.00	15,600.00
5	Power Sprayer	2	Piece	16,000.00	32,000.00
6	Traffic Vest	10	Piece	500.00	5000.00
TOTAL					96,700.00

**The list of safety and emergency supplies and equipment above is based on the recommended supplies and equipment to ensure Disaster Preparedness in schools according to the Enhanced Basic Education Information Systems (EBEIS). Also, above were recommended to support DO 53, s. 2022 or the Mandatory Unannounced Earthquake and Fire Drills in schools.*

- a) The unit cost indicated in the table above is estimated based on a market study conducted by the DepEd DRRMS. The actual prices of the safety and emergency supplies and equipment may vary depending on the prevailing market price in the locality. It is the responsibility of the Schools Division Offices (SDOs) to ensure that the identified schools are provided with the listed supplies and equipment.
 - b) If the prevailing market prices are higher than the estimated prices, the SDOs, in coordination with the concerned schools, shall prioritize the procurement of the necessary items. If there are remaining funds due to lower prices, the SDOs may use the remaining funds for the same purpose, for the same schools, subject to the rules and regulations of RA 9184.
5. The implementation and monitoring of the procurement and delivery of Safety and Emergency Supplies and Equipment to the schools shall be led by the Division DRRM Coordinator, in coordination with the School Heads and School DRRM Coordinators of the concerned schools.
 6. It is the responsibility of schools to maintain the procured safety and emergency supplies and equipment with the support of the Schools Division Offices, Local Government Units, or Local Partners/Stakeholders. The procured safety and emergency supplies and equipment shall be placed in the most accessible location within the school.
 7. The funds downloaded to SDOs for this purpose shall be considered an augmentation and support intervention from DepEd Central Office. However, ensuring Disaster Preparedness in schools, particularly ensuring the availability of emergency supplies and equipment, shall remain the primary responsibility of the SDOs and Regional Offices (ROs).
 8. In case the prescribed equipment is not available, the Divisions may opt to procure other priority DRRM supplies and equipment. The Division office shall submit justification on the change of items to be procured, subject to the approval of the Regional office.
 9. To ensure proper documentation and monitoring of this activity, the Regional and Division Budget Officers shall coordinate with the Regional and Division DRRM Coordinators and refer to the General Guidelines on the reporting and submission of fund utilization.

APPROVED:

ANNALYN M. SEVILLA
Undersecretary for Finance

ATTY. REVSEE A. ESCOBEDO
Undersecretary for Operations

ANNEX E.1: IMPLEMENTING GUIDELINES OF THE FY 2023 DISASTER PREPAREDNESS AND RESPONSE PROGRAM FUNDS FOR CLEAN-UP AND MINOR REPAIR

1. Affected school/s that meet any of the following criteria will receive funds amounting to P20,000 for clean-up and minor repairs:
 - a. School incurred a totally damaged classroom;
 - b. School incurred a partially major damaged classroom;
 - c. School incurred a minimum of 10 damaged school furniture;
 - d. School incurred a minimum of 100 damaged learning resources;
 - e. School incurred a minimum of 10 damaged DCP components; and
 - f. School with less than 10 damaged units of two (2) or more components of non-infrastructure items.
2. All damages meeting the criteria above must be indicated in the **Rapid Assessment of Damages Report (RADaR)** or Incident Report that has been submitted to the Disaster Risk Reduction and Management Service (DRRMS).
3. If a school did not incur any infrastructure and non-infrastructure damages but requires cleaning and clearing operations based on a rapid assessment conducted by the regional or division DRRM Team, the school can be provided with clean-up and minor repair funds. The Schools Division Superintendent must submit a signed official request certifying the need of the school. The Division DRRM Coordinator should submit this request to the DRRMS for approval, with a copy furnished to the Regional Director.
4. The downloaded funds may be utilized for the following activities:
 - a. Purchase of supplies, tools, materials, and equipment needed for cleaning and clearing operations and repair of minor damages in the school;
 - b. Payment for the labor services of non-DepEd personnel;
 - c. Provision of meals for volunteers involved in cleaning and clearing operations and repair of minor damages in the school; and
 - d. Other expenses related to the clean-up and minor repair of the school.
5. All tools and equipment purchased by the schools using the clean-up and minor repair fund must be properly accounted for, maintained, and safely stored in the school for future use.

APPROVED:

ANNALYN M. SEVILLA
Undersecretary for Finance

ATTY. REVSEE A. ESCOBEDO
Undersecretary for Operations

ANNEX E.2: IMPLEMENTING GUIDELINES OF THE FY 2023 DISASTER PREPAREDNESS AND RESPONSE PROGRAM FUNDS FOR THE CONSTRUCTION OF DEPED TEMPORARY LEARNING SPACES (TLS)

***For Temporary Learning Spaces (TLS):
Immediate Response in the Aftermath of a Disaster Reported through the RADaR and/or Incident Report:***

1. Affected school/s that meet any of the following criteria will receive Response Intervention funds for the construction of TLS:
 - a. School incurred a totally damaged classroom; and
 - b. School incurred a partially major damaged classroom.
2. All damages meeting the criteria above must be indicated in the Rapid Assessment of Damages Report (RADaR) and/or Incident Report that has been submitted to the Disaster Risk Reduction and Management Service (DRRMS), or Incident Report submitted to the Regional Office.
3. If a school did not incur any damages in classrooms, but requires TLS based on a rapid assessment conducted by the regional or division DRRM Team, the school can be provided with TLS funds. The Schools Division Superintendent must submit a signed official request certifying the need of the school.

Schools affected by Previous Disasters and/or Emergencies reported in the RADaR and/or Incident Report but not yet provided TLS

This process flow shall be observed by the schools affected by the previous disasters and/or emergencies in requesting funds for Temporary Learning Spaces (TLS) reported either through RADaR or Incident Report :

1. The School DRRM Coordinator (SDRRMC) shall ensure that the school was included in the vetted Rapid Assessment and Damages Report (RADaR) and/or incident report approved by the Division and Regional DRRM Coordinator, Schools Division Superintendent, and Regional Director and submitted to the DRRMS. The SDRRMC shall prepare and submit a report to the School Head on the number of TLS needed.
2. The School head of the requesting school shall certify the need for the TLS and submit the said report to the Schools Division Office.
3. To validate the report, the Schools Division Office through the DRRM Coordinator with the Division Engineer shall conduct validation of the recipient school. They shall submit a certification and recommendation to the Office of the Schools Division Superintendent for approval copy furnished by the recipient school.

4. The Schools Division Superintendent shall endorse the said certification and recommendation to the Regional Office through the Regional DRRM Coordinator for vetting and clearance.
5. The Regional Director shall endorse the submitted report to the Office of the Director, Disaster Risk Reduction and Management Service Central Office for review and ensure the completeness of the submitted documents.
6. The DRRMS shall prepare the necessary response and recommend the request for the provision of TLS to the office of the Undersecretaries for Operations and Finance for approval and necessary action.
7. The DRRMS shall furnish the Regional Office copy of the action taken from the Central Office.
8. If approved, the Regional Office through the Regional DRRM Coordinator, shall endorse the approved request to the Budget Officer for the processing of the Sub-Allotment Release Order (Sub-ARO) then to be submitted to the Regional Director for approval.
9. All funding requests shall be subject to the availability of funds and the existing accounting and auditing rules and regulations.

I. Pre-Procurement

1. Modification of DepEd TLS Design

- a. **Enclosure 9** presents the standard DepEd TLS design, along with a list of materials required for construction. If pre-approved standard materials are not available, Divisions may procure alternative materials from the local area.
- b. Any changes in materials, design, and specifications must be prepared by the Division or Regional Engineer in coordination with the DRRM Coordinator and approved by the Division Superintendent. Any modifications made should adhere to safety and functionality standards intended for DepEd TLS, which include, but are not limited to, the following:
 - i. DepEd TLS should last for a minimum of six months;
 - ii. The size of DepEd TLS should follow the standard dimensions of 7.2 X 8.4 meters, as indicated in Annex A (Standard DepEd TLS Design);
 - iii. DepEd TLS should have proper ventilation and lighting to create a conducive learning environment;
 - iv. The TLS should have walls to provide protection and minimize distractions from the surroundings; and
 - v. The location of DepEd TLS should be in a safe area within the school premises. If there is no safe

area within the school premises, the school, in coordination with the LGU and other relevant government offices, should search for a safe and accessible area within the community and facilitate the necessary documentation for the construction of TLS, subject to existing rules and regulations.

- c. Any changes in DepEd TLS materials, design, and specifications must be reported by divisions immediately to the Office of the Undersecretary for Operations (OUOPs), with copies sent to the Office of the Undersecretary for School Infrastructure and Facilities (OUSIF), Finance Service, DRRMS, and EFD. The following documents must be submitted:
 - i. A written narrative on the justification for such changes signed by the Superintendent;
 - ii. A modified DepEd TLS design with corresponding costs prepared by the Engineer and approved by the Superintendent; and
 - iii. An accomplished Temporary Learning Spaces (TLS) School Level Monitoring Template listed in Annex B.
- d. The cost of each modified DepEd TLS unit should not exceed the standard amount provided by the DepEd Central Office.
- e. The labor costs for construction can be reduced by involving internal and external partners and stakeholders, such as the Parent-Teacher Association, Local Government Units, Government agencies (e.g., AFP, BFP, DSWD), and other civil society organizations and programs in the locality.

2. Realignment requests

- a. If there are changes in DepEd TLS needs, divisions may request the realignment of funds provided that:
 - i. The funds requested for realignment will be used for procuring supplies, materials and labor for constructing DepEd TLS for other schools;
 - ii. The new recipient schools identified by the Division have not received DepEd TLS from DRRMS, or they have a shortage of classrooms due to disaster or emergency;
 - iii. The original schools with DepEd TLS allocation confirm the changes in TLS needs through written documentation; and
 - iv. The funds are realigned to affected schools within the same division.
- b. To request for the realignment of DepEd TLS, the following documents should be submitted:
 - i. A written narrative signed by the Superintendent, stating the changes in TLS needs and

- interventions that require the realignment of DepEd TLS from one school to another;
 - ii. A written documentation from the original school/s, signed by the School Head/s, stating the changes in TLS need or the decision to no longer avail DepEd TLS for the fiscal year;
 - iii. A request letter from the new recipient school/s, signed by the School Head, indicating the need for TLS and availability of a safe and accessible location; and
 - iv. A vetted Rapid Assessment of Damage Report (RADaR) 1 or Incident Report of the identified new school/s to receive DepEd TLS. The Incident Report should include the number of damaged classrooms and total TLS needed.
- c. The request for realignment of funds and change of recipient school/s must be submitted to the DRRMS for review and endorsement to the Director for Finance for further review and approval by the Office of the Undersecretary for Operations and Undersecretary for Finance.
- d. If the original school/s no longer require the response intervention and the division has not identified any new recipient school/s, the division must facilitate the negative Sub-ARO.

II. Procurement

1. The funds allocated for DepEd TLS may only be used for the procurement of materials and labor necessary for construction. Divisions are allowed to proceed with the procurement of materials, supplies, and labor for DepEd TLS, short of award, while waiting for the issuance of the Sub-ARO.
2. Procurement of materials and labor must comply with existing procurement procedures. The Division may use various suitable procurement methods. Alternative procurement methods may be employed, subject to the completion of necessary requirements such as the revision and approval of the Annual Procurement Plan (APP) and the action of the Head of the Procuring Entity (HoPE).¹
3. The division can download the TLS funds to both implementing and non-implementing school units.
4. If the school does not have an existing Bids and Awards Committee (BAC), the following options may be considered:
 - a. The school can enter into a Memorandum of Agreement (MOA) with a nearby school that has an existing BAC. The school with the BAC can conduct the procurement process

¹ Refer to GPPB NPM No. 003-2020 Section 53 (b) RA 9184; also 53.2 of the 2016 IRR

KS

and sign procurement documents through the MOA. The end-user school will sign post-procurement documents such as delivery receipts, disbursement vouchers, payroll, etc.

- b. The procurement process at the school level shall be coordinated and reported by the School Head as the HoPE to their respective local Commission on Audit (COA) office.

III. Construction

- 1. All DepEd TLS should adhere to the approved standard design provided by DepEd Central Office, or the modified design approved by the division. Safety and accessibility of the construction site must also be ensured through coordination with the LGU.

IV. Monitoring and Assessment

- 1. The Division Engineer and/or Regional Engineer, in coordination with the DRRM Coordinator, will provide regular progress updates on TLS construction to the Schools Division Superintendent (SDS).
- 2. The Division and/or Regional Engineer, in coordination with the Division DRRM Coordinator, shall assess the safety of the TLS six months after construction completion and provide necessary recommendations to the SDS. These recommendations may include whether to continue or discontinue the use of the TLS, needed repairs and maintenance, and other relevant matters.

APPROVED:

ANNALYN M. SEVILLA
Undersecretary for Finance

ATTY. REVSEE A. ESCOBEDO
Undersecretary for Operations

ANNEX E.3: **IMPLEMENTING GUIDELINES ON THE USE OF THE FY 2023 DISASTER PREPAREDNESS AND RESPONSE PROGRAM FUNDS FOR RESPONSE MOBILIZATION**

The Disaster Preparedness and Response Program (DPRP) fund of this component is available to support the implementation of activities corresponding to preparedness for response-related interventions.

1. The following activities are eligible for funding under this component of DPRP:
 - a. Conduct of Regional and Division DRRM Coordination meetings in the aftermath of disasters and/or emergencies;
 - b. Monitoring visits to areas hardly hit by a disaster and/or emergency;
 - c. Provision and/or procurement of Response-related interventions such as but not limited to Learners, kits, Teachers kits, Emergency School Feeding, and other response-related interventions that the division may identify which is deemed necessary subject to justification by the DRRM Coordinator and approved by the Schools Division Superintendent concerned, and
 - d. Implementation of other response-related activities based on the identified needs of the regions and divisions

2. Only the following expenses are allowed for this component of DPRP:
 - a. Travel expenses including Board and lodging necessary for monitoring and evaluation, and school visits to areas hardly hit both by a disaster and/or human-induced hazards; and
 - b. Payment for the conduct of procurement and/or delivery of disaster response-related interventions.

3. Region and Schools Division Offices fund allocation for FY 2023 is provided in **Enclosure 1b: Summary of Allocation for Regional Offices for Response Interventions**.

4. Regional and Division DRRM Coordinators shall submit the status of program implementation and fund utilization on a quarterly basis using **Enclosure 5: Quarterly Status of the FY 2023 Disaster Preparedness and Response Program on the Implementation of Disaster Preparedness-related PPAs and Response Interventions**.

5. All forms must be prepared by the DRRM Coordinator, reviewed by the Budget Officer, and approved by the Regional Director for the Regional Office or the Schools Division Superintendent for the Division Office. All approved forms/reports shall be submitted to the DRRMS on or before the last week of every quarter.

B

6. The report must be addressed to the Director IV of the DRRMS using the email: drmo@deped.gov.ph with the subject: DPRP[DR-Int2023] Region/Division | Report (e.g., DPRP[DR-Int2023] Region III Report; DPRP[DR-Int2023] Region III SDO Pampanga Report).

APPROVED:

ANNALYN M. SEVILLA
Undersecretary for Finance

ATTY. REVSEE A. ESCOBEDO
Undersecretary for Operations

ANNEX E.4: IMPLEMENTING GUIDELINES OF THE FY 2023 DISASTER PREPAREDNESS AND RESPONSE PROGRAM FUNDS FOR PSYCHOLOGICAL FIRST AID (PFA) MOBILIZATION

1. To obtain funds for the mobilization of PFA, the DRRM Coordinator, in coordination with the division school health personnel or nurses, shall prepare and submit a request letter to the Schools Division Superintendent. The letter should be signed by the SDS and addressed to the Regional Director for approval, with copies furnished to the DRRMS and BLSS-SHD.
2. The request letter should include the following information:
 - a. Date and name of the disaster or emergency;
 - b. Number of participants to receive PFA based on needs assessment by school health personnel or nurses;
 - c. Capacity assessment of the division to provide PFA, including available partnerships and linkages;
 - d. Timeline for the conduct of PFA; and
 - e. Total amount required for the mobilization of PFA.
3. Allowable expenses for PFA mobilization funds may include the following:
 - a. Board and lodging for PFA organizers, providers, and participants, if PFA sessions will be held live-in and outside the schools;
 - b. Meals and snacks for PFA organizers, providers, and participants;
 - c. Art and workshop materials for PFA sessions;
 - d. Play kits for learners;
 - e. Printing of reference materials for learners for the conduct of PFA;
 - f. Transportation expenses for PFA organizers and providers;
 - g. Transportation expenses for PFA participants (for personnel only), if PFA sessions will be live-out and conducted in the schools;
 - h. Communication expenses for PFA organizers and providers;
 - i. Surgical masks and alcohol/sanitizer, especially during an outbreak of a communicable disease; and
 - j. Payment of honorarium for resource persons based on existing DBM guidelines.
4. The recommended budget per participant for PFA provision is Four Hundred Fifty Pesos (P450.00) for a duration of two (2) half-day sessions in a school setting, as presented below:

Item	Cost	Frequency	Total
Supplies and Materials	150.00	1	150.00
Snacks	150.00	2	300.00
GRAND TOTAL			450.00

5. The budget estimate for PFA provision to personnel requiring board and lodging, whether it will be conducted in or outside of the school, shall adhere to the guidelines outlined in DepEd Order No. 02, s. 2018 titled *Amendment to DepEd Order No. 15, s. 2017 (Guidelines on the Allocation of Funds for Venue, Meals and Snacks, and Room Accommodation for Official Activities Organized and Conducted by the Department of Education)*.

6. The amount of the Play kit to be provided per 40 learners shall not exceed the amount of Six Thousand Pesos (P6,000.00). The breakdown of the suggested contents of kit is listed below:

No	Item	Quantity	Unit of Measure	Estimated Unit Cost	Estimated Total Cost
1	Stress ball, 7cm diameter	10	Piece	50.00	500.00
2	Ready Kid Stuffed Toy or Storybook for Elementary; Coloring Book for Secondary		Piece	--	500.00
3	Puzzle	5	Piece	200.00	1,000.00
4	Musical instrument	2	Piece	1,000.00	2,000.00
5	Emotion Cards	1	Set	200.00	200.00
6	Fidget Toys (for SPED learner)	10	Piece	30.00	300.00
7	Board Game	2	Piece	500.00	1,000.00
8	Plastic container	1	Box	500.00	500.00
GRAND TOTAL					6,000.00

7. The total amount to be downloaded to the implementing unit (division office or school) shall be according to the number of target participants.
8. The estimated unit costs indicated in the table above are based on prevailing market prices. The actual market price of the above-listed supplies may vary.
9. In the event that the prevailing market prices are higher than the estimated price, the SDOs, in coordination with the concerned schools shall prioritize the items to be procured. In the event that the prevailing market prices are lower than the estimated price, the SDOs shall utilize the remaining funds for the same purpose.
10. Procurement of supplies must comply with existing procurement procedures. The Division may use various suitable procurement methods. Alternative procurement methods may be employed, subject to the completion of necessary requirements such as the revision and approval of the Annual Procurement Plan (APP) and the action of the Head of the Procuring Entity (HoPE).²
11. The division can download the Play Kit funds to both implementing and non-implementing school units, as long as there is an existing Bids and Awards Committee (BAC) in the school.
12. If the school does not have an existing Bids and Awards Committee (BAC), the following options may be considered:

² Refer to GPPB NPM No. 003-2020 Section 53 (b) RA 9184; also 53.2 of the 2016 IRR

KS

- a. The school can enter into a Memorandum of Agreement (MOA) with a nearby school that has an existing BAC. The school with the BAC can conduct the procurement process and sign procurement documents through the MOA. The end-user school will sign post-procurement documents such as delivery receipts, disbursement vouchers, payroll, etc.
- b. The procurement process at the school level shall be coordinated and reported by the School Head as the HoPE to their respective local Commission on Audit (COA) office.

13. The division office shall monitor the provision of the Play Kit/s to the affected school/s.

APPROVED:

ANNALYN M. SEVILLA
Undersecretary for Finance

ATTY. REVSEE A. ESCOBEDO
Undersecretary for Operations

ANNEX E.5: IMPLEMENTING GUIDELINES OF THE FY 2023 DISASTER PREPAREDNESS AND RESPONSE PROGRAM FUNDS FOR THE CONSTRUCTION OF DEPED TEMPORARY WASH FACILITIES (TWF)

The DepEd TWF was designed by the DepEd Education Facilities Division. This will be provided to affected schools with damaged toilets, based on a vetted RADaR or Incident Report submitted to the Disaster Risk Reduction and Management Service based on the effect of natural and human-induced disasters and/or emergencies.

The provision of TWF shall be an Immediate Response in the Aftermath of a Disaster Reported in the RADaR. To be able to qualify as a recipient, the following shall be considered:

1. Affected school/s that meet any of the following criteria will receive funds for Temporary Water, Sanitation, and Hygiene Facility (TWF):
 - a. School incurred a totally damaged WASH Facility; and
 - b. School incurred a partially major damaged WASH Facility.
2. All damages meeting the criteria above must be indicated in the Rapid Assessment of Damages Report (RADaR) that has been submitted to the Disaster Risk Reduction and Management Service (DRRMS), or Incident Report submitted to the Regional Office.
3. If a school did not incur any damages in classrooms, but requires TWF based on a rapid assessment conducted by the regional or division DRRM Team, the school can be provided with TWF funds. The Schools Division Superintendent must submit a signed official request certifying the need of the school.

I. Pre-Procurement

1. Site selection

- a. The Division and/or Regional Engineer, in coordination with the DRRM Coordinator and WinS Coordinators, shall conduct site selection for the construction of the TWF in schools.
- b. The site must have the following:
 - i. Safe and accessible location within the school premises;
 - ii. Water supply for handwashing, toilet use, menstrual hygiene management, and cleaning purposes for all learners and personnel; and
 - iii. Proper drainage and waste disposal.

2. Modification of DepEd TWF Design

- a. The standard DepEd TWF design and a list of required construction materials are presented in **Enclosure 10**. If the pre-approved standard materials are not available, divisions may procure alternative materials from the local area.

- b. Modifications to the standard materials, design, and specifications must be proposed by the Division or Regional Engineer in coordination with the DRRM and WinS Coordinators, and approved by the Division Superintendent. Any changes made must comply with safety and functionality standards set for DepEd TWF, including but not limited to the following:
 - i. DepEd TWF should last for a minimum of six months;
 - ii. The size of each comfort room must meet the minimum standard size as per plan;³
 - iii. The unit must be sex-segregated and inclusive;
 - iv. The unit must have a functional indoor lock; and
 - v. The unit must have a dedicated shelf for female use.
- c. Any changes in DepEd TWF materials, design, and specifications must be reported by divisions immediately to the Office of the Undersecretary for Operations (OUOps), with copies sent to the Office of the Undersecretary for School Infrastructure and Facilities (OUSIF), Finance Service, DRRMS, and EFD. The following documents must be submitted:
 - i. A written narrative on the justification for such changes signed by the Superintendent;
 - ii. A modified DepEd TWF design with corresponding costs prepared by the Engineer and approved by the Superintendent; and
 - iii. An accomplished TWF School Level Monitoring Template listed in **Enclosure 5**.
- d. The cost of each modified DepEd TWF unit should not exceed the standard amount provided by the DepEd Central Office.
- e. The labor costs for construction can be reduced by involving internal and external partners and stakeholders, such as the Parent-Teacher Association, Local Government Units, Government agencies (e.g., AFP, BFP, DSWD), and other civil society organizations and programs in the locality.

3. Realignment requests

- a. If there are changes in DepEd TWF needs, divisions may request the realignment of funds provided that:
 - i. The funds requested for realignment will be used for procuring materials and labor for constructing DepEd TWF for other schools;
 - ii. The new recipient schools identified by the Division have not received DepEd TWF from DRRMS;

³ Based on Batas Pambansa Bilang 344, Accessibility Law"

- iii. The original schools with DepEd TWF allocation confirm the changes in TWF needs through written documentation; and
 - iv. The funds are realigned to affected schools within the same division.
- b. To request for the realignment of DepEd TWF, the following documents should be submitted:
- i. A written narrative signed by the Superintendent, stating the changes in TWF needs and interventions that require the realignment of DepEd TWF from one school to another;
 - ii. A written documentation from the original school/s, signed by the School Head/s, stating the changes in TWF need or the decision to no longer avail DepEd TWF for the fiscal year;
 - iii. A request letter from the new recipient school/s, signed by the School Head, indicating the need for TWF and availability of a safe and accessible location; and
 - iv. A vetted Rapid Assessment of Damage Report (RADaR) 1 or Incident Report of the identified new school/s to receive DepEd TWF. The Incident Report should include the number of damaged toilets.
- c. The request for realignment of funds and change of recipient school/s must be submitted to the DRRMS for review and endorsement to the Director for Finance for further review and approval by the Office of the Undersecretary for Operations and Undersecretary for Finance.
- d. If the original school/s no longer require the response intervention and the division has not identified any new recipient school/s, the division must facilitate the negative Sub-ARO.

II. Procurement

1. The funds allocated for DepEd TWF may only be used for the procurement of materials and labor necessary for construction. Divisions are allowed to proceed with the procurement of materials and labor for DepEd TWF, short of award, while waiting for the issuance of the Sub-ARO.
2. Procurement of materials and labor must comply with existing procurement procedures. The Division may use various suitable procurement methods. Alternative procurement methods may be employed, subject to the completion of necessary requirements such

as the revision and approval of the Annual Procurement Plan (APP) and the action of the Head of the Procuring Entity (HoPE).⁴

3. The division can download the TWF funds to both implementing and non-implementing school units, as long as there is an existing Bids and Awards Committee (BAC) in the school.
4. If the school does not have an existing Bids and Awards Committee (BAC), the following options may be considered:
 - a. The school can enter into a Memorandum of Agreement (MOA) with a nearby school that has an existing BAC. The school with the BAC can conduct the procurement process and sign procurement documents through the MOA. The end-user school will sign post-procurement documents such as delivery receipts, disbursement vouchers, payroll, etc.
 - b. The procurement process at the school level shall be coordinated and reported by the School Head as the HoPE to their respective local Commission on Audit (COA) office.

Construction

5. The DepEd TWF design to be constructed in the affected school shall be the prescribed design by the DepEd Central office or the modified design approved by the SDS.
6. The Division and/or Regional Engineer in coordination with the LGU and DRRM and WinS Coordinators shall ensure that the construction is according to the implementation plan and standards on health and safety.

III. Monitoring and Assessment

1. The Division Engineer and/or Regional Engineer, in coordination with the DRRM and WinS Coordinators, shall provide regular progress updates on TWF construction to the Schools Division Superintendent (SDS).
2. The Division and/or Regional Engineer, in coordination with the Division DRRM and WinS Coordinators, shall assess the safety of the TWF six months after construction completion and provide necessary recommendations to the SDS. These recommendations may include whether to continue or discontinue the use of the TWF, needed repairs and maintenance, and other relevant matters.

IV. Operations and Maintenance

⁴ Refer to GPPB NPM No. 003-2020 Section 53 (b) RA 9184; also 53.2 of the 2016 IRR

1. The school, in coordination with the LGU, PTA, and other relevant stakeholders and partners, shall plan for the operations and maintenance of the facility, following the standards below:
 - a. Ensure a regular supply of clean water during school hours.
 - b. Implement proper solid waste management within the school premises.
 - c. Provide for proper septage and wastewater disposal.
 - d. Conduct daily cleaning and maintenance activities such as leak checks, repair of indoor locks and partitions, water supply and accessory repairs, and monitoring water quality.
 - e. Maintain a regular supply of soap in the facility.
 - f. Establish mechanisms for effective menstrual hygiene management.
 - g. Make sanitary pads and mirrors easily accessible inside the TWF.
2. The Division and/or Regional WinS Coordinator shall ensure that accurate and clear information on proper handwashing, toilet facility usage, and proper disposal of sanitary pads is prominently displayed in the vicinity of the TWF.
3. Six months after the completion of construction, the Division and/or Regional Engineer, in coordination with the Division DRRM and WinS Coordinators, shall assess the safety of the TWF and provide necessary recommendations to the SDS. These recommendations may include whether to continue or discontinue the use of the TWF, needed repairs and maintenance, and other relevant matters.

APPROVED:

ANNALYN M. SEVILLA
Undersecretary for Finance

ATTY. REVSEE A. ESCOBEDO
Undersecretary for Operations

ANNEX F: IMPLEMENTING GUIDELINES OF THE FY 2023 DISASTER PREPAREDNESS AND RESPONSE PROGRAM FUNDS FOR CENTRAL OFFICE-MANAGE FUNDS FOR RESPONSE INTERVENTIONS

Rationale:

The approved **Two Billion Pesos** (PhP 2,000,000,000.00) of the FY 2023 Disaster Preparedness and Response Program funds will be used for the implementation of Disaster Preparedness-related PPAs and Response Interventions for field offices. Of this amount, a total of **One Billion Seven Hundred Ninety-Seven Million One Hundred Twenty-Six Thousand Eight Hundred Pesos** (PhP 1,797,126,800.00) will be prepositioned to the Regional offices as indicated in **Enclosure 1c: Summary of FY 2023 Disaster Preparedness and Response Program Funds Downloaded to Field offices.**

The remaining **Two Hundred Two Million Eight Hundred Seventy-Three Thousand and Two Hundred Pesos** (PhP 202,873,200.00) shall serve as standby fund. The said fund will be managed by the DepEd Central Office-DRRMS and will be used for the following:

- Replenish the funds for the provision of response interventions of field offices, as requested;
- Provide fund support for the provision of technical assistance on the implementation of and monitoring of fund utilization for response interventions through field visits, coordination meetings, etc.

Replenishment of Funds for Response Interventions:

1. Regional office may request for replenishment for response interventions provided that **75%** of its regional standby (Disaster Response) downloaded funds have been obligated. The said concerned field office shall provide the following required documents for the replenishment request:
 - a. Request letter signed by the Regional Director addressed to the Undersecretary for Finance and Undersecretary for Operations, attention to the Director IV of the Disaster Risk Reduction and Management Service;
 - b. Copies of the Physical accomplishments; and
 - c. Copies of Obligation and liquidation report signed by the DRRM Coordinator, reviewed by the Budget Officer and approved by the Regional Director.
2. Upon completion of the above documentary requirements, the regional office shall submit the request to the DepEd-DRRMS at drmmc@deped.gov.ph;
3. Upon receipt of the request letter from the regional office, the DRRMS shall prepare the necessary documents and endorse the said request to the Office of the Undersecretary for Operations and Office of the Undersecretary for Finance for review and approval; and

4. Upon approval of the concerned EXECOM offices, the DRRMS shall endorse the approved documents to the Finance Service for the preparation of Sub-Allotment Release Order (Sub-ARO).
3. All allowable expenses are subject to the existing accounting and auditing rules and regulations.

APPROVED:

ANNALYN M. SEVILLA
Undersecretary for Finance

ATTY. REVSEE A. ESCOBEDO
Undersecretary for Operations

Enclosure 1a: Summary of Allocation for Regional Offices for Disaster Preparedness-related PPAs

DISASTER PREPAREDNESS						
Regions	Contingency Plan	Implementation of DRRM PPAs	Procurement of Preparedness Equipment	Public Service Continuity Plan	Total	
CAR	19,953,600.00	17,629,250.00	7,542,600.00	2,300,000.00	47,425,450.00	
CARAGA	23,326,900.00	20,024,250.00	12,764,400.00	3,450,000.00	59,565,550.00	
NCR	12,322,900.00	13,220,250.00	5,898,700.00	4,600,000.00	36,041,850.00	
Region I	33,257,200.00	26,336,250.00	16,825,800.00	4,025,000.00	80,444,250.00	
Region II	28,013,400.00	20,285,250.00	5,995,400.00	2,587,500.00	56,881,550.00	
Region III	43,088,100.00	33,038,250.00	16,729,100.00	5,750,000.00	98,605,450.00	
Region IV-A	41,729,300.00	32,395,250.00	30,944,000.00	6,325,000.00	111,393,550.00	
Region IV-B	26,062,200.00	19,621,250.00	7,059,100.00	2,012,500.00	54,755,050.00	
Region V	43,294,400.00	30,053,250.00	5,802,000.00	3,737,500.00	82,887,150.00	
Region VI	46,862,700.00	34,248,250.00	15,762,100.00	6,037,500.00	102,910,550.00	
Region VII	41,912,900.00	29,879,250.00	15,665,400.00	5,462,500.00	92,920,050.00	
Region VIII	46,881,900.00	31,049,250.00	7,155,800.00	3,737,500.00	88,824,450.00	
Region IX	28,075,500.00	20,089,250.00	14,891,800.00	2,300,000.00	65,356,550.00	
Region X	29,602,200.00	23,536,250.00	4,061,400.00	4,025,000.00	61,224,850.00	
Region XI	25,807,400.00	21,518,250.00	8,896,400.00	3,162,500.00	59,384,550.00	
Region XII	23,837,700.00	19,076,250.00	16,245,600.00	2,300,000.00	61,459,550.00	
Grand Total	514,028,300.00	392,000,000.00	192,239,600.00	61,812,500.00	1,160,080,400.00	

Enclosure 1b: Summary of Allocation for Regional Offices for Response Interventions

Regions	DISASTER RESPONSE (Regional Standby Funds)								Total	Standby Fund (Augmentation)	
	Temporary Learning Spaces	Clean-Up and Minor Repair	Response Mobilization	Psychological First Aid	Temporary WASH Facility	Temporary Learning Spaces	Clean-Up and Minor Repair	Response Mobilization			
CAR	14,940,000.00	5,000,000.00	5,998,000.00	5,000,000.00	2,000,000.00	5,000,000.00	5,000,000.00	5,998,000.00	2,000,000.00	32,938,000.00	10,100,000.00
CARAGA	17,280,000.00	5,800,000.00	6,796,500.00	5,000,000.00	2,000,000.00	5,000,000.00	5,000,000.00	6,796,500.00	2,000,000.00	36,876,500.00	11,700,000.00
NCR	2,880,000.00	1,000,000.00	1,996,800.00	5,000,000.00	2,000,000.00	5,000,000.00	5,000,000.00	1,996,800.00	2,000,000.00	12,876,800.00	873,200.00
Region I	9,000,000.00	3,000,000.00	3,997,400.00	5,000,000.00	2,000,000.00	5,000,000.00	5,000,000.00	3,997,400.00	2,000,000.00	22,997,400.00	6,000,000.00
Region II	50,940,000.00	17,000,000.00	17,998,000.00	5,000,000.00	2,000,000.00	5,000,000.00	5,000,000.00	17,998,000.00	2,000,000.00	92,938,000.00	33,600,000.00
Region III	4,680,000.00	1,600,000.00	2,597,000.00	5,000,000.00	2,000,000.00	5,000,000.00	5,000,000.00	2,597,000.00	2,000,000.00	15,877,000.00	3,200,000.00
Region IV-A	5,400,000.00	1,800,000.00	2,795,300.00	5,000,000.00	2,000,000.00	5,000,000.00	5,000,000.00	2,795,300.00	2,000,000.00	16,995,300.00	4,700,000.00
Region IV-B	12,600,000.00	4,200,000.00	5,199,500.00	5,000,000.00	2,000,000.00	5,000,000.00	5,000,000.00	5,199,500.00	2,000,000.00	28,999,500.00	8,300,000.00
Region V	93,600,000.00	31,200,000.00	32,195,200.00	5,000,000.00	2,000,000.00	5,000,000.00	5,000,000.00	32,195,200.00	2,000,000.00	163,995,200.00	61,700,000.00
Region VI	13,680,000.00	4,600,000.00	5,594,400.00	5,000,000.00	2,000,000.00	5,000,000.00	5,000,000.00	5,594,400.00	2,000,000.00	30,874,400.00	9,200,000.00
Region VII	36,000,000.00	12,000,000.00	12,998,300.00	5,000,000.00	2,000,000.00	5,000,000.00	5,000,000.00	12,998,300.00	2,000,000.00	67,998,300.00	24,600,000.00
Region VIII	17,280,000.00	5,800,000.00	6,796,500.00	5,000,000.00	2,000,000.00	5,000,000.00	5,000,000.00	6,796,500.00	2,000,000.00	36,876,500.00	11,700,000.00
Region IX	1,800,000.00	600,000.00	1,593,200.00	5,000,000.00	2,000,000.00	5,000,000.00	5,000,000.00	1,593,200.00	2,000,000.00	10,993,200.00	1,500,000.00
Region X	2,880,000.00	1,000,000.00	1,996,800.00	5,000,000.00	2,000,000.00	5,000,000.00	5,000,000.00	1,996,800.00	2,000,000.00	12,876,800.00	1,000,000.00
Region XI	10,800,000.00	3,600,000.00	4,597,600.00	5,000,000.00	2,000,000.00	5,000,000.00	5,000,000.00	4,597,600.00	2,000,000.00	25,997,600.00	7,200,000.00
Region XII	11,340,000.00	3,800,000.00	4,795,900.00	5,000,000.00	2,000,000.00	5,000,000.00	5,000,000.00	4,795,900.00	2,000,000.00	26,935,900.00	7,500,000.00
Grand Total	305,100,000.00	102,000,000.00	117,946,400.00	80,000,000.00	32,000,000.00	80,000,000.00	80,000,000.00	117,946,400.00	32,000,000.00	637,046,400.00	202,873,200.00

Enclosure 1c: Summary of FY 2023 Disaster Preparedness and Response Program Funds Downloaded to Field Offices

REGIONS	DISASTER PREPAREDNESS	DISASTER RESPONSE (Regional Standby Funds)	TOTAL
CAR	47,425,450.00	32,938,000.00	80,363,450.00
CARAGA	59,565,550.00	36,876,500.00	96,442,050.00
NCR	36,041,850.00	12,876,800.00	48,918,650.00
Region I	80,444,250.00	22,997,400.00	103,441,650.00
Region II	56,881,550.00	92,938,000.00	149,819,550.00
Region III	98,605,450.00	15,877,000.00	114,482,450.00
Region IVA	111,393,550.00	16,995,300.00	128,388,850.00
Region IVB	54,755,050.00	28,999,500.00	83,754,550.00
Region V	82,887,150.00	163,995,200.00	246,882,350.00
Region VI	102,910,550.00	30,874,400.00	133,784,950.00
Region VII	92,920,050.00	67,998,300.00	160,918,350.00
Region VIII	88,824,450.00	36,876,500.00	125,700,950.00
Region IX	65,356,550.00	10,993,200.00	76,349,750.00
Region X	61,224,850.00	12,876,800.00	74,101,650.00
Region XI	59,384,550.00	25,997,600.00	85,382,150.00
Region XII	61,459,550.00	26,935,900.00	88,395,450.00
TOTAL	1,160,080,400.00	637,046,400.00	1,797,126,800.00

Enclosure 1d: Summary of FY 2023 Disaster Preparedness and Response Program Funds Distribution

REGIONS	DISASTER PREPAREDNESS	DISASTER RESPONSE (Regional Standby Funds)	STANDBY FUNDS (Central Office Managed)	TOTAL
CAR	47,425,450.00	32,938,000.00	10,100,000.00	90,463,450.00
CARAGA	59,565,550.00	36,876,500.00	11,700,000.00	108,142,050.00
NCR	36,041,850.00	12,876,800.00	873,200.00	49,791,850.00
Region I	80,444,250.00	22,997,400.00	6,000,000.00	109,441,650.00
Region II	56,881,550.00	92,938,000.00	33,600,000.00	183,419,550.00
Region III	98,605,450.00	15,877,000.00	3,200,000.00	117,682,450.00
Region IVA	111,393,550.00	16,995,300.00	4,700,000.00	133,088,850.00
Region IVB	54,755,050.00	28,999,500.00	8,300,000.00	92,054,550.00
Region V	82,887,150.00	163,995,200.00	61,700,000.00	308,582,350.00
Region VI	102,910,550.00	30,874,400.00	9,200,000.00	142,984,950.00
Region VII	92,920,050.00	67,998,300.00	24,600,000.00	185,518,350.00
Region VIII	88,824,450.00	36,876,500.00	11,700,000.00	137,400,950.00
Region IX	65,356,550.00	10,993,200.00	1,500,000.00	77,849,750.00
Region X	61,224,850.00	12,876,800.00	1,000,000.00	75,101,650.00
Region XI	59,384,550.00	25,997,600.00	7,200,000.00	92,582,150.00
Region XII	61,459,550.00	26,935,900.00	7,500,000.00	95,895,450.00
TOTAL	1,160,080,400.00	637,046,400.00	202,873,200.00	2,000,000,000.00
Percentage Share	58%	32%	10%	100%

**Department of Education
DISASTER RISK REDUCATION AND MANAGEMENT SERVICE**

**Enclosure 2: Breakdown of FY 2023 Disaster Preparedness and Response
Program**

**Implementation of Disaster Risk Reduction and Management (DRRM)
Programs, Projects, and Activities**

REGION	ALLOCATION
CAR	17,629,250.00
CARAGA	20,024,250.00
NCR	13,220,250.00
REGION I	26,336,250.00
REGION II	20,285,250.00
REGION III	33,038,250.00
REGION IV-A	32,395,250.00
REGION IV-B	19,621,250.00
REGION V	30,053,250.00
REGION VI	34,248,250.00
REGION VII	29,879,250.00
REGION VIII	31,049,250.00
REGION IX	20,089,250.00
REGION X	23,536,250.00
REGION XI	21,518,250.00
REGION XII	19,076,250.00
TOTAL	392,000,000.00

**Department of Education
DISASTER RISK REDUCATION AND MANAGEMENT SERVICE**

**Enclosure 2: Breakdown of FY 2023 Disaster Preparedness and Response
Program**

**Implementation of Disaster Risk Reduction and Management (DRRM)
Programs, Projects, and Activities**

REGION: CAR

OFFICE	ALLOCATION
REGIONAL OFFICE	6,684,250.00
Abra	1,917,000.00
Apayao	1,200,000.00
Baguio City	568,000.00
Benguet	2,430,000.00
Ifugao	1,566,000.00
Kalinga	1,094,000.00
Mt. Province	1,567,000.00
Tabuk City	603,000.00
TOTAL	17,629,250.00

**Department of Education
DISASTER RISK REDUCATION AND MANAGEMENT SERVICE**

**Enclosure 2: Breakdown of FY 2023 Disaster Preparedness and Response
Program**

**Implementation of Disaster Risk Reduction and Management (DRRM)
Programs, Projects, and Activities**

REGION: CARAGA

OFFICE	ALLOCATION
REGIONAL OFFICE	7,327,250.00
Agusan del Norte	1,206,000.00
Agusan del Sur	2,518,000.00
Bayugan City	570,000.00
Bislig City	570,000.00
Butuan City	840,000.00
Cabadbaran City	535,000.00
Dinagat Island	842,000.00
Siargao	845,000.00
Surigao City	587,000.00
Surigao del Norte	1,201,000.00
Surigao del Sur	2,452,000.00
Tandag City	531,000.00
TOTAL	20,024,250.00

**Department of Education
DISASTER RISK REDUCATION AND MANAGEMENT SERVICE**

**Enclosure 2: Breakdown of FY 2023 Disaster Preparedness and Response
Program**

**Implementation of Disaster Risk Reduction and Management (DRRM)
Programs, Projects, and Activities**

REGION: NCR

OFFICE	ALLOCATION
REGIONAL OFFICE	4,092,250.00
Caloocan City	589,000.00
City of San Juan	513,000.00
Las Piñas City	539,000.00
Makati City	537,000.00
Malabon City	542,000.00
Mandaluyong City	524,000.00
Manila	605,000.00
Marikina City	533,000.00
Muntinlupa City	527,000.00
Navotas	525,000.00
Paranaque City	543,000.00
Pasay City	529,000.00
Pasig City	544,000.00
Quezon City	959,000.00
Taguig	548,000.00
Valenzuela City	571,000.00
TOTAL	13,220,250.00

**Department of Education
DISASTER RISK REDUCATION AND MANAGEMENT SERVICE**

**Enclosure 2: Breakdown of FY 2023 Disaster Preparedness and Response
Program**

**Implementation of Disaster Risk Reduction and Management (DRRM)
Programs, Projects, and Activities**

REGION: I

OFFICE	ALLOCATION
REGIONAL OFFICE	9,275,250.00
Alaminos City	546,000.00
Batac City	533,000.00
Candon City	534,000.00
Dagupan City	539,000.00
Ilocos Norte	2,164,000.00
Ilocos Sur	2,506,000.00
La Union	2,286,000.00
Laoag City	539,000.00
Pangasinan I, Lingayen	2,661,000.00
Pangasinan II, Binalonan	2,559,000.00
San Carlos City	576,000.00
San Fernando City	533,000.00
Urduaneta City	564,000.00
Vigan City	521,000.00
TOTAL	26,336,250.00

**Department of Education
DISASTER RISK REDUCATION AND MANAGEMENT SERVICE**

**Enclosure 2: Breakdown of FY 2023 Disaster Preparedness and Response
Program**

**Implementation of Disaster Risk Reduction and Management (DRRM)
Programs, Projects, and Activities**

REGION: II

OFFICE	ALLOCATION
REGIONAL OFFICE	8,448,250.00
Batanes	527,000.00
Cagayan	2,806,000.00
Cauayan City	580,000.00
City of Ilagan	598,000.00
Isabela	2,881,000.00
Nueva Vizcaya	2,281,000.00
Quirino	1,087,000.00
Santiago City	541,000.00
Tuguegarao City	536,000.00
TOTAL	20,285,250.00

**Department of Education
DISASTER RISK REDUCATION AND MANAGEMENT SERVICE**

Enclosure 2: Breakdown of FY 2023 Disaster Preparedness and Response Program

Implementation of Disaster Risk Reduction and Management (DRRM) Programs, Projects, and Activities

REGION: III

OFFICE	ALLOCATION
REGIONAL OFFICE	11,431,250.00
Angeles City	553,000.00
Aurora	974,000.00
Balanga City	522,000.00
Bataan	1,213,000.00
Bulacan	2,540,000.00
Cabanatuan City	565,000.00
Gapan City	557,000.00
Mabalacat City	541,000.00
Malolos City	555,000.00
Meycauayan City	557,000.00
Munoz Science City	530,000.00
Nueva Ecija	2,747,000.00
Olongapo City	540,000.00
Pampanga	2,558,000.00
San Fernando City	546,000.00
San Jose City	557,000.00
San Jose del Monte City	536,000.00
Tarlac	2,504,000.00
Tarlac City	598,000.00
Zambales	1,914,000.00
TOTAL	33,038,250.00

**Department of Education
DISASTER RISK REDUCATION AND MANAGEMENT SERVICE**

Enclosure 2: Breakdown of FY 2023 Disaster Preparedness and Response Program

Implementation of Disaster Risk Reduction and Management (DRRM) Programs, Projects, and Activities

REGION: IV-A

OFFICE	ALLOCATION
REGIONAL OFFICE	11,041,250.00
Antipolo City	567,000.00
Bacoor City	543,000.00
Batangas	2,763,000.00
Batangas City	609,000.00
Binan City	538,000.00
Cabuyao City	528,000.00
Calamba City	573,000.00
Cavite	1,928,000.00
Cavite City	514,000.00
Dasmarinas City	544,000.00
General Trias City	536,000.00
Imus City	535,000.00
Laguna	2,045,000.00
Lipa City	585,000.00
Lucena City	554,000.00
Quezon	2,960,000.00
Rizal	1,802,000.00
San Pablo City	580,000.00
San Pedro City	528,000.00
Sta. Rosa City	528,000.00
Sto. Tomas City	500,000.00
Tanauan City	559,000.00
Tayabas City	535,000.00
TOTAL	32,395,250.00

**Department of Education
DISASTER RISK REDUCATION AND MANAGEMENT SERVICE**

**Enclosure 2: Breakdown of FY 2023 Disaster Preparedness and Response
Program**

**Implementation of Disaster Risk Reduction and Management (DRRM)
Programs, Projects, and Activities**

REGION: IV-B

OFFICE	ALLOCATION
REGIONAL OFFICE	8,043,250.00
Calapan City	558,000.00
Marinduque	1,329,000.00
Occidental Mindoro	2,163,000.00
Oriental Mindoro	2,538,000.00
Palawan	2,819,000.00
Puerto Princesa City	601,000.00
Romblon	1,570,000.00
TOTAL	19,621,250.00

**Department of Education
DISASTER RISK REDUCATION AND MANAGEMENT SERVICE**

**Enclosure 2: Breakdown of FY 2023 Disaster Preparedness and Response
Program**

**Implementation of Disaster Risk Reduction and Management (DRRM)
Programs, Projects, and Activities**

REGION: V

OFFICE	ALLOCATION
Regional Office	11,801,250.00
Albay	2,554,000.00
Camarines Norte	1,917,000.00
Camarines Sur	3,091,000.00
Catanduanes	1,568,000.00
Iriga City	550,000.00
Legaspi City	556,000.00
Ligao City	567,000.00
Masbate	2,699,000.00
Masbate City	544,000.00
Naga City	542,000.00
Sorsogon	2,531,000.00
Sorsogon City	583,000.00
Tabaco City	550,000.00
TOTAL	30,053,250.00

**Department of Education
DISASTER RISK REDUCATION AND MANAGEMENT SERVICE**

**Enclosure 2: Breakdown of FY 2023 Disaster Preparedness and Response
Program**

**Implementation of Disaster Risk Reduction and Management (DRRM)
Programs, Projects, and Activities**

REGION: VI

OFFICE	ALLOCATION
REGIONAL OFFICE	12,300,250.00
Aklan	2,279,000.00
Antique	2,535,000.00
Bacolod City	570,000.00
Bago City	547,000.00
Cadiz City	569,000.00
Capiz	2,471,000.00
Escalante City	541,000.00
Guimaras	615,000.00
Himamaylan City	554,000.00
Iloilo	3,170,000.00
Iloilo City	566,000.00
Kabankalan City	591,000.00
La Carlota City	529,000.00
Negros Occidental	2,576,000.00
Passi City	544,000.00
Roxas City	550,000.00
Sagay City	566,000.00
San Carlos City	565,000.00
Silay City	539,000.00
Sipalay City	547,000.00
Victorias City	524,000.00
TOTAL	34,248,250.00

**Department of Education
DISASTER RISK REDUCATION AND MANAGEMENT SERVICE**

**Enclosure 2: Breakdown of FY 2023 Disaster Preparedness and Response
Program**

**Implementation of Disaster Risk Reduction and Management (DRRM)
Programs, Projects, and Activities**

REGION: VII

OFFICE	ALLOCATION
REGIONAL OFFICE	11,604,250.00
Bais City	559,000.00
Bayawan City	593,000.00
Bogo City	538,000.00
Bohol	3,106,000.00
Canlaon City	500,000.00
Carcar City	549,000.00
Cebu	3,120,000.00
Cebu City	607,000.00
City of Naga, Cebu	555,000.00
Danao City	561,000.00
Dumaguete City	525,000.00
Guihulngan City	600,000.00
Lapu-Lapu City	571,000.00
Mandaue City	545,000.00
Negros Oriental	2,544,000.00
Siquijor	578,000.00
Tagbilaran City	524,000.00
Talisay City	544,000.00
Tanjay City	594,000.00
Toledo City	562,000.00
TOTAL	29,879,250.00

**Department of Education
DISASTER RISK REDUCATION AND MANAGEMENT SERVICE**

Enclosure 2: Breakdown of FY 2023 Disaster Preparedness and Response Program

Implementation of Disaster Risk Reduction and Management (DRRM) Programs, Projects, and Activities

REGION: VIII

OFFICE	ALLOCATION
REGIONAL OFFICE	12,660,250.00
Baybay City	583,000.00
Biliran	843,000.00
Borongan City	558,000.00
Calbayog City	974,000.00
Catbalogan City	558,000.00
Eastern Samar	2,466,000.00
Leyte	3,270,000.00
Maasin City	578,000.00
Northern Samar	2,608,000.00
Ormoc City	600,000.00
Samar (Western Samar)	2,749,000.00
Southern Leyte	2,042,000.00
Tacloban City	560,000.00
TOTAL	31,049,250.00

**Department of Education
DISASTER RISK REDUCATION AND MANAGEMENT SERVICE**

**Enclosure 2: Breakdown of FY 2023 Disaster Preparedness and Response
Program**

**Implementation of Disaster Risk Reduction and Management (DRRM)
Programs, Projects, and Activities**

REGION: IX

OFFICE	ALLOCATION
REGIONAL OFFICE	8,451,250.00
Dapitan City	559,000.00
Dipolog City	548,000.00
Isabela City	564,000.00
Pagadian City	582,000.00
Zamboanga City	1,316,000.00
Zamboanga del Norte	2,757,000.00
Zamboanga del Sur	2,806,000.00
Zamboanga Sibugay	2,506,000.00
TOTAL	20,089,250.00

**Department of Education
DISASTER RISK REDUCATION AND MANAGEMENT SERVICE**

**Enclosure 2: Breakdown of FY 2023 Disaster Preparedness and Response
Program**

**Implementation of Disaster Risk Reduction and Management (DRRM)
Programs, Projects, and Activities**

REGION: X

OFFICE	ALLOCATION
REGIONAL OFFICE	8,413,250.00
Bukidnon	2,648,000.00
Cagayan de Oro City	614,000.00
Camiguin	566,000.00
El Salvador	523,000.00
Gingoog City	595,000.00
Iligan City	612,000.00
Lanao del Norte	2,283,000.00
Malaybalay City	585,000.00
Misamis Occidental	2,037,000.00
Misamis Oriental	2,421,000.00
Oroquieta City	551,000.00
Ozamis City	558,000.00
Tangub City	565,000.00
Valencia City	565,000.00
TOTAL	23,536,250.00

**Department of Education
DISASTER RISK REDUCATION AND MANAGEMENT SERVICE**

**Enclosure 2: Breakdown of FY 2023 Disaster Preparedness and Response
Program**

**Implementation of Disaster Risk Reduction and Management (DRRM)
Programs, Projects, and Activities**

REGION: XI

OFFICE	ALLOCATION
REGIONAL OFFICE	7,610,250.00
Davao City	2,432,000.00
Davao De Oro	2,419,000.00
Davao del Norte	1,562,000.00
Davao del Sur	1,561,000.00
Davao Occidental	1,213,000.00
Davao Oriental	1,927,000.00
Digos City	546,000.00
Island Garden City of Samar	575,000.00
Mati City	572,000.00
Panabo City	562,000.00
Tagum City	539,000.00
TOTAL	21,518,250.00

**Department of Education
DISASTER RISK REDUCATION AND MANAGEMENT SERVICE**

**Enclosure 2: Breakdown of FY 2023 Disaster Preparedness and Response
Program**

**Implementation of Disaster Risk Reduction and Management (DRRM)
Programs, Projects, and Activities**

REGION: XII

OFFICE	ALLOCATION
REGIONAL OFFICE	7,436,250.00
General Santos City	603,000.00
Kidapawan City	575,000.00
Koronadal City	555,000.00
North Cotabato	2,773,000.00
Sarangani	1,923,000.00
South Cotabato	2,281,000.00
Sultan Kudarat	2,399,000.00
Tacurong City	531,000.00
TOTAL	19,076,250.00

**Department of Education
Disaster Risk Reduction and Management Service
Region/Schools Division Office**

Enclosure 4: FY 2023 DPRP Photo Documentation on the Conduct of Disaster Preparedness-related PPAs and Response Interventions

I. Narrative:

II. Photo Documentation with Caption:

III. Propose Outcome/Impact:

Prepared by:

Approved:

DRRM Coordinator

**Regional Director/
Schools Division Superintendent**

Enclosure 6: FY 2023 DPRP Allocation of Funds for Regions and Divisions for the Enhancement and/or Development of Contingency Plans in DepEd Field Office and Schools

FIELD OFFICES	ALLOCATION
CAR	19,953,600.00
CAR RO	
Abra	3,444,800.00
Apayao	2,163,900.00
Baguio City	801,200.00
Benguet	4,581,500.00
Ifugao	2,709,800.00
Kalinga	2,005,700.00
Mt. Province	2,915,800.00
Tabuk City	1,222,900.00
CARAGA	23,326,900.00
CARAGA RO	
Agusan del Norte	2,163,900.00
Agusan del Sur	5,553,400.00
Bayugan City	852,700.00
Bislig City	832,100.00
Butuan City	1,604,000.00
Cabadbaran City	502,500.00
Dinagat Island	1,604,000.00
Siargao	1,593,700.00
Surigao City	986,600.00
Surigao del Norte	2,225,700.00
Surigao del Sur	4,839,000.00
Tandag City	461,300.00

Enclosure 6: FY 2023 DPRP Allocation of Funds for Regions and Divisions for the Enhancement and/or Development of Contingency Plans in DepEd Field Office and Schools

FIELD OFFICES	ALLOCATION
NCR	12,322,900.00
NCR RO	
Caloocan City	1,088,600.00
City of San Juan	377,900.00
Las Piñas City	604,500.00
Makati City	614,800.00
Malabon City	676,600.00
Mandaluyong City	491,200.00
Manila	1,324,900.00
Marikina City	583,900.00
Muntinlupa City	491,200.00
Navotas	501,500.00
Paranaque City	676,600.00
Pasay City	532,400.00
Pasig City	697,200.00
Quezon City	1,891,400.00
Taguig City and Pateros	686,900.00
Valenzuela City	975,300.00
Region I	33,257,200.00
Region 1 RO	
Alaminos City	717,800.00
Batac City	583,900.00
Candon City	583,900.00
Dagupan City	645,700.00
Ilocos Norte	4,020,600.00
Ilocos Sur	5,490,600.00
La Union	4,185,400.00
Laoag City	645,700.00
Pangasinan I, Lingayen	7,142,300.00
Pangasinan II, Binalonan	6,067,400.00
San Carlos City	1,026,800.00
San Fernando City	573,600.00
Urdaneta City	903,200.00
Vigan City	460,300.00

Enclosure 6: FY 2023 DPRP Allocation of Funds for Regions and Divisions for the Enhancement and/or Development of Contingency Plans in DepEd Field Office and Schools

FIELD OFFICES	ALLOCATION
Region II	28,013,400.00
Region 2 RO	
Batanes	522,100.00
Cagayan	8,423,200.00
Cauayan City	954,700.00
City of Ilagan	1,243,100.00
Isabela	9,137,600.00
Nueva Vizcaya	4,092,700.00
Quirino	2,148,900.00
Santiago City	666,300.00
Tuguegarao City	614,800.00
Region III	43,088,100.00
Region 3 RO	
Angeles City	789,900.00
Aurora	2,056,200.00
Balanga City	470,600.00
Bataan	2,379,200.00
Bulacan	5,861,400.00
Cabánatuan City	913,500.00
City of San Jose Del Monte	831,100.00
Gapan City	666,300.00
Mabalacat City	779,600.00
Malolos City	831,100.00
Meycauayan City	553,000.00
Nueva Ecija	7,990,600.00
Olongapo City	656,000.00
Pampanga	5,933,500.00
San Fernando City	707,500.00
San Jose City	831,100.00
Science City of Muñoz	614,800.00
Tarlac	5,397,900.00
Tarlac City	1,222,500.00
Zambales	3,392,300.00

Enclosure 6: FY 2023 DPRP Allocation of Funds for Regions and Divisions for the Enhancement and/or Development of Contingency Plans in DepEd Field Office and Schools

FIELD OFFICES	ALLOCATION
Region IV-A	41,729,300.00
Region IV-A RO	
Antipolo City	934,100.00
Bacoor City	656,000.00
Batangas	8,176,000.00
Batangas City	1,386,700.00
Binan City	594,200.00
Cabuyao City	522,100.00
Calamba City	985,600.00
Cavite	3,577,700.00
Cavite City	388,200.00
Dasmariñas City	697,200.00
General Trias City	594,200.00
Imus City	583,900.00
Laguna	3,618,900.00
Lipa City	1,119,500.00
Lucena City	738,400.00
Quezon	10,109,500.00
Rizal	3,299,600.00
San Pablo City	1,068,000.00
San Pedro City	491,200.00
Sta. Rosa City	522,100.00
Sto. Tomas	
Tanauan City	851,700.00
Tayabas City	604,500.00
Region IV-B	26,062,200.00
Region 4B RO	
Calapan City	841,400.00
Marinduque	2,595,500.00
Occidental Mindoro	3,660,100.00
Oriental Mindoro	5,758,400.00
Palawan	8,663,800.00
Puerto Princesa City	1,284,300.00
Romblon	3,048,700.00

Enclosure 6: FY 2023 DPRP Allocation of Funds for Regions and Divisions for the Enhancement and/or Development of Contingency Plans in DepEd Field Office and Schools

FIELD OFFICES	ALLOCATION
Region V	43,294,400.00
Region 5 RO	
Albay	5,974,700.00
Camarines Norte	3,557,100.00
Camarines Sur	11,534,600.00
Catanduanes	3,038,400.00
Iriga City	748,700.00
Legaspi City	820,800.00
Ligao City	882,600.00
Masbate	7,547,700.00
Masbate City	697,200.00
Naga City	676,600.00
Sorsogon	5,748,100.00
Sorsogon City	1,098,900.00
Tabaco City	759,000.00
Region VI	46,862,700.00
Region 6 RO	
Aklan	4,175,100.00
Antique	5,820,200.00
Bacolod City	923,800.00
Bago City	728,100.00
Cadiz City	892,900.00
Capiz	5,126,400.00
Escalante City	666,300.00
Guimaras	1,448,500.00
Himamaylan City	800,200.00
Iloilo	12,424,100.00
Iloilo City	923,800.00
Kabankalan City	1,171,000.00
La Carlota City	532,400.00
Negros Occidental	6,005,600.00
Passi City	686,900.00
Roxas City	748,700.00
Sagay City	923,800.00
San Carlos City	913,500.00
Silay City	625,100.00
Sipalay City	666,300.00
Victorias City	450,000.00

Enclosure 6: FY 2023 DPRP Allocation of Funds for Regions and Divisions for the Enhancement and/or Development of Contingency Plans in DepEd Field Office and Schools

FIELD OFFICES	ALLOCATION
Region VII	41,912,900.00
Region 7 RO	
Bais City	851,700.00
Bayawan City	1,006,200.00
Bogo City	635,400.00
Bohol	11,754,600.00
Canlaon City	-
Carcar City	738,400.00
Cebu	11,225,600.00
Cebu City	1,284,300.00
City of Naga, Cebu	810,500.00
Danao City	872,300.00
Dumaguete City	501,500.00
Guihulngan City	1,253,400.00
Lapu-Lapu City	810,500.00
Mandaue City	614,800.00
Negros Oriental	5,188,200.00
Siquijor	1,047,400.00
Tagbilaran City	480,900.00
Talisay City	656,000.00
Tanjay City	1,098,900.00
Toledo City	872,300.00
Region VIII	46,881,900.00
Region 8 RO	
Baybay City	1,098,900.00
Biliran	1,736,900.00
Borongan City	831,100.00
Calbayog City	2,045,900.00
Catbalogan City	841,400.00
Eastern Samar	5,085,200.00
Leyte	13,416,600.00
Maasin City	1,047,400.00
Northern Samar	6,555,200.00
Ormoc City	1,274,000.00
Samar (Western Samar)	8,062,700.00
Southern Leyte	3,814,600.00
Tacloban City	862,000.00

Enclosure 6: FY 2023 DPRP Allocation of Funds for Regions and Divisions for the Enhancement and/or Development of Contingency Plans in DepEd Field Office and Schools

FIELD OFFICES	ALLOCATION
Region IX	28,075,500.00
Region 9 RO	
Dapitan City	851,700.00
Dipolog City	738,400.00
Isabela City	903,200.00
Pagadian City	1,088,600.00
Zamboanga City	2,471,900.00
Zamboanga del Norte	7,815,500.00
Zamboanga del Sur	8,464,400.00
Zamboanga Sibugay	5,531,800.00
Region X	29,602,200.00
Region 10 RO	
Bukidnon	6,915,700.00
Cagayan de Oro City	1,427,900.00
Camiguin	923,800.00
El Salvador	480,900.00
Gingoog City	1,171,000.00
Iligan City	1,314,600.00
Lanao del Norte	4,216,300.00
Malaybalay City	1,119,500.00
Misamis Occidental	3,752,800.00
Misamis Oriental	4,642,300.00
Oroquieta City	769,300.00
Ozamis City	841,400.00
Tangub City	913,500.00
Valencia City	903,200.00

Enclosure 6: FY 2023 DPRP Allocation of Funds for Regions and Divisions for the Enhancement and/or Development of Contingency Plans in DepEd Field Office and Schools

FIELD OFFICES	ALLOCATION
Region XI	25,807,400.00
Region 11 RO	
Davao City	4,704,100.00
Davao De Oro	4,590,800.00
Davao del Norte	2,966,300.00
Davao del Sur	2,966,300.00
Davao Occidental	2,471,900.00
Davao Oriental	3,660,100.00
Digos City	717,800.00
Island Garden City of Samal	1,016,500.00
Mati City	975,300.00
Panabo City	882,600.00
Tagum City	645,700.00
Region XII	23,837,700.00
SOCCKSARGEN RO	
General Santos City	1,212,200.00
Kidapawan City	1,016,500.00
Koronadal City	789,900.00
North Cotabato	8,083,300.00
Sarangani	3,598,300.00
South Cotabato	4,030,900.00
Sultan Kudarat	4,333,300.00
Tacurong City	563,300.00

**Enclosure 7: FY 2023 DPRP-Allocation of Funds for Regions and Divisions
for the Enhancement and/or Development of Pubic Service Continuity
Plan**

FIELD OFFICE	ALLOCATION
CAR	2,300,000.00
CAR RO	
Abra	287,500.00
Apayao	287,500.00
Baguio City	287,500.00
Benguet	287,500.00
Ifugao	287,500.00
Kalinga	287,500.00
Mt. Province	287,500.00
Tabuk City	287,500.00
CARAGA	3,450,000.00
CARAGA RO	
Agusan del Norte	287,500.00
Agusan del Sur	287,500.00
Bayugan City	287,500.00
Bislig City	287,500.00
Butuan City	287,500.00
Cabadbaran City	287,500.00
Dinagat Island	287,500.00
Siargao	287,500.00
Surigao City	287,500.00
Surigao del Norte	287,500.00
Surigao del Sur	287,500.00
Tandag City	287,500.00

**Enclosure 7: FY 2023 DPRP-Allocation of Funds for Regions and Divisions
for the Enhancement and/or Development of Pubic Service Continuity
Plan**

FIELD OFFICE	ALLOCATION
NCR	4,600,000.00
NCR RO	
Caloocan City	287,500.00
City of San Juan	287,500.00
Las Piñas City	287,500.00
Makati City	287,500.00
Malabon City	287,500.00
Mandaluyong City	287,500.00
Manila	287,500.00
Marikina City	287,500.00
Muntinlupa City	287,500.00
Navotas	287,500.00
Paranaque City	287,500.00
Pasay City	287,500.00
Pasig City	287,500.00
Quezon City	287,500.00
Taguig City and Pateros	287,500.00
Valenzuela City	287,500.00

**Enclosure 7: FY 2023 DPRP-Allocation of Funds for Regions and Divisions
for the Enhancement and/or Development of Pubic Service Continuity
Plan**

FIELD OFFICE	ALLOCATION
Region I	4,025,000.00
Region 1 RO	
Alaminos City	287,500.00
Batac City	287,500.00
Candon City	287,500.00
Dagupan City	287,500.00
Ilocos Norte	287,500.00
Ilocos Sur	287,500.00
La Union	287,500.00
Laoag City	287,500.00
Pangasinan I, Lingayen	287,500.00
Pangasinan II, Binalonan	287,500.00
San Carlos City	287,500.00
San Fernando City	287,500.00
Urdaneta City	287,500.00
Vigan City	287,500.00
Region II	2,587,500.00
Region 2 RO	
Batanes	287,500.00
Cagayan	287,500.00
Cauayan City	287,500.00
City of Ilagan	287,500.00
Isabela	287,500.00
Nueva Vizcaya	287,500.00
Quirino	287,500.00
Santiago City	287,500.00
Tuguegarao City	287,500.00

**Enclosure 7: FY 2023 DPRP-Allocation of Funds for Regions and Divisions
for the Enhancement and/or Development of Public Service Continuity
Plan**

FIELD OFFICE	ALLOCATION
Region III	5,750,000.00
Region 3 RO	
Angeles City	287,500.00
Aurora	287,500.00
Balanga City	287,500.00
Bataan	287,500.00
Bulacan	287,500.00
Cabanatuan City	287,500.00
City of San Jose Del Monte	287,500.00
Gapan City	287,500.00
Mabalacat City	287,500.00
Malolos City	287,500.00
Meycauayan City	287,500.00
Nueva Ecija	287,500.00
Olongapo City	287,500.00
Pampanga	287,500.00
San Fernando City	287,500.00
San Jose City	287,500.00
Science City of Muñoz	287,500.00
Tarlac	287,500.00
Tarlac City	287,500.00
Zambales	287,500.00

**Enclosure 7: FY 2023 DPRP-Allocation of Funds for Regions and Divisions
for the Enhancement and/or Development of Pubic Service Continuity
Plan**

FIELD OFFICE	ALLOCATION
Region IV-A	6,325,000.00
Region IV-A RO	
Antipolo City	287,500.00
Bacoor City	287,500.00
Batangas	287,500.00
Batangas City	287,500.00
Binan City	287,500.00
Cabuyao City	287,500.00
Calamba City	287,500.00
Cavite	287,500.00
Cavite City	287,500.00
Dasmaringas City	287,500.00
General Trias City	287,500.00
Imus City	287,500.00
Laguna	287,500.00
Lipa City	287,500.00
Lucena City	287,500.00
Quezon	287,500.00
Rizal	287,500.00
San Pablo City	287,500.00
San Pedro City	287,500.00
Sta. Rosa City	287,500.00
Sto. Tomas	
Tanauan City	287,500.00
Tayabas City	287,500.00

**Enclosure 7: FY 2023 DPRP-Allocation of Funds for Regions and Divisions
for the Enhancement and/or Development of Public Service Continuity
Plan**

FIELD OFFICE	ALLOCATION
Region IV-B	2,012,500.00
Region 4B RO	
Calapan City	287,500.00
Marinduque	287,500.00
Occidental Mindoro	287,500.00
Oriental Mindoro	287,500.00
Palawan	287,500.00
Puerto Princesa City	287,500.00
Romblon	287,500.00
Region V	3,737,500.00
Region 5 RO	
Albay	287,500.00
Camarines Norte	287,500.00
Camarines Sur	287,500.00
Catanduanes	287,500.00
Iriga City	287,500.00
Legaspi City	287,500.00
Ligao City	287,500.00
Masbate	287,500.00
Masbate City	287,500.00
Naga City	287,500.00
Sorsogon	287,500.00
Sorsogon City	287,500.00
Tabaco City	287,500.00

**Enclosure 7: FY 2023 DPRP-Allocation of Funds for Regions and Divisions
for the Enhancement and/or Development of Public Service Continuity
Plan**

FIELD OFFICE	ALLOCATION
Region VI	6,037,500.00
Region 6 RO	
Aklan	287,500.00
Antique	287,500.00
Bacolod City	287,500.00
Bago City	287,500.00
Cadiz City	287,500.00
Capiz	287,500.00
Escalante City	287,500.00
Guimaras	287,500.00
Himamaylan City	287,500.00
Iloilo	287,500.00
Iloilo City	287,500.00
Kabankalan City	287,500.00
La Carlota City	287,500.00
Negros Occidental	287,500.00
Passi City	287,500.00
Roxas City	287,500.00
Sagay City	287,500.00
San Carlos City	287,500.00
Silay City	287,500.00
Sipalay City	287,500.00
Victorias City	287,500.00

**Enclosure 7: FY 2023 DPRP-Allocation of Funds for Regions and Divisions
for the Enhancement and/or Development of Public Service Continuity
Plan**

FIELD OFFICE	ALLOCATION
Region VII	5,462,500.00
Region 7 RO	
Bais City	287,500.00
Bayawan City	287,500.00
Bogo City	287,500.00
Bohol	287,500.00
Canlaon City	-
Carcar City	287,500.00
Cebu	287,500.00
Cebu City	287,500.00
City of Naga, Cebu	287,500.00
Danao City	287,500.00
Dumaguete City	287,500.00
Guihulngan City	287,500.00
Lapu-Lapu City	287,500.00
Mandaue City	287,500.00
Negros Oriental	287,500.00
Siquijor	287,500.00
Tagbilaran City	287,500.00
Talisay City	287,500.00
Tanjay City	287,500.00
Toledo City	287,500.00

**Enclosure 7: FY 2023 DPRP-Allocation of Funds for Regions and Divisions
for the Enhancement and/or Development of Public Service Continuity
Plan**

FIELD OFFICE	ALLOCATION
Region VIII	3,737,500.00
Region 8 RO	
Baybay City	287,500.00
Biliran	287,500.00
Borongan City	287,500.00
Calbayog City	287,500.00
Catbalogan City	287,500.00
Eastern Samar	287,500.00
Leyte	287,500.00
Maasin City	287,500.00
Northern Samar	287,500.00
Ormoc City	287,500.00
Samar (Western Samar)	287,500.00
Southern Leyte	287,500.00
Tacloban City	287,500.00
Region IX	2,300,000.00
Region 9 RO	
Dapitan City	287,500.00
Dipolog City	287,500.00
Isabela City	287,500.00
Pagadian City	287,500.00
Zamboanga City	287,500.00
Zamboanga del Norte	287,500.00
Zamboanga del Sur	287,500.00
Zamboanga Sibugay	287,500.00

**Enclosure 7: FY 2023 DPRP-Allocation of Funds for Regions and Divisions
for the Enhancement and/or Development of Public Service Continuity
Plan**

FIELD OFFICE	ALLOCATION
Region X	4,025,000.00
Region 10 RO	
Bukidnon	287,500.00
Cagayan de Oro City	287,500.00
Camiguin	287,500.00
El Salvador	287,500.00
Gingoog City	287,500.00
Iligan City	287,500.00
Lanao del Norte	287,500.00
Malaybalay City	287,500.00
Misamis Occidental	287,500.00
Misamis Oriental	287,500.00
Oroquieta City	287,500.00
Ozamis City	287,500.00
Tangub City	287,500.00
Valencia City	287,500.00
Region XI	3,162,500.00
Region 11 RO	
Davao City	287,500.00
Davao De Oro	287,500.00
Davao del Norte	287,500.00
Davao del Sur	287,500.00
Davao Occidental	287,500.00
Davao Oriental	287,500.00
Digos City	287,500.00
Island Garden City of Samal	287,500.00
Mati City	287,500.00
Panabo City	287,500.00
Tagum City	287,500.00
Region XII	2,300,000.00
SOCCKSARGEN RO	
General Santos City	287,500.00
Kidapawan City	287,500.00
Koronadal City	287,500.00
North Cotabato	287,500.00
Sarangani	287,500.00
South Cotabato	287,500.00
Sultan Kudarat	287,500.00
Tacurong City	287,500.00

Enclosure 8: List of School Beneficiaries of the Safety and Emergency Supplies and Equipment

No.	Region	Division	School ID	School Name	Sum of Total
1	CAR	Abra	135175	Bucloc CS	61
2	CAR	Abra	135199	Apao Primary School	70
3	CAR	Abra	305080	Capitan NHS	77
4	CAR	Abra	305083	Dalit National High School	86
5	CAR	Abra	305101	Suyo National High School	74
6	CAR	Abra	305103	Tiempo NHS	106
7	CAR	Abra	318701	MARC YSRAEL B. BERNOS MEMORIAL NATIONAL HIGH SCHOOL	61
8	CAR	Abra	501106	NAGLIBACAN INTEGRATED SCHOOL	66
9	CAR	Apayao	135236	Macalino ES	69
10	CAR	Apayao	135302	Cabetayan ES	64
11	CAR	Apayao	305117	Marag Valley Agr'l. and Trade HS	62
12	CAR	Baguio City	136393	Bonifacio Elementary School	68
13	CAR	Baguio City	136399	Don Mariano Marcos Elementary School	61
14	CAR	Baguio City	136416	San Vicente Elementary School	64
15	CAR	Baguio City	305275	Mil-an National High School	61
16	CAR	Baguio City	305280	Irisan National High School	62
17	CAR	Benguet	135393	Naguey ES	61
18	CAR	Benguet	135418	Lamew ES	65
19	CAR	Benguet	135482	Cayat-Laduan Elementary School (formerly Ladoan PS)	66
20	CAR	Benguet	135492	Pasbol-Belino Elementary School	62
21	CAR	Benguet	135495	Sagandoy ES	62
22	CAR	Benguet	135498	Tin-apan PS	91
23	CAR	Benguet	135506	Labilab ES	79
24	CAR	Benguet	135508	Loacan ES	66
25	CAR	Benguet	135509	Luneta Elementary School	61
26	CAR	Benguet	135597	Kibungan CS	97
27	CAR	Benguet	135602	Enrique Jose ES	83
28	CAR	Benguet	135619	Bekkel ES	61
29	CAR	Benguet	135620	Benguet SPED Center	72
30	CAR	Benguet	135644	Bedbed Elementary School	69
31	CAR	Benguet	135646	Cabacab Elementary School	64
32	CAR	Benguet	135652	Guiweng PS	66
33	CAR	Benguet	219530	Yugo-Bantales Elementary School	66
34	CAR	Benguet	305125	Alejo M. Pacalso Memorial National High School	77
35	CAR	Benguet	305126	Ampucao National High School	78
36	CAR	Benguet	305127	Loacan National High School	71
37	CAR	Benguet	305128	Ampusongan National High School	82
38	CAR	Benguet	305129	Atok National High School	72
39	CAR	Benguet	305130	Camp 30 National High School	93
40	CAR	Benguet	305133	Benguet National High School	62
41	CAR	Benguet	305135	Bokod National High School	61
42	CAR	Benguet	305137	Catubong National High School	68

No.	Region	Division	School ID	School Name	Sum of Total
43	CAR	Benguet	305138	Loo National High School	78
44	CAR	Benguet	305140	Cordillera Regional Science High School	72
45	CAR	Benguet	305141	Evelio Javier Memorial National High School	82
46	CAR	Benguet	305144	Guinaoang National High School	98
47	CAR	Benguet	305146	Adaoay National High School	99
48	CAR	Benguet	305151	Lepanto National High School	64
49	CAR	Benguet	305155	Mankayan National High School	66
50	CAR	Benguet	305158	Sinipsip National High School	72
51	CAR	Benguet	305161	Taloy Sur NHS	72
52	CAR	Benguet	305162	Tublay School of Home Industries	83
53	CAR	Benguet	318901	Daklan National High School	91
54	CAR	Benguet	318905	La Trinidad National High School	68
55	CAR	Benguet	318907	Bantic National High School	81
56	CAR	Benguet	318914	Marcelo Marquez National High School	63
57	CAR	Ifugao	135892	Pullaan ES	61
58	CAR	Ifugao	135955	Tinoc CS	69
59	CAR	Ifugao	305167	Asipulo National High School	64
60	CAR	Ifugao	305178	Hingyon NHS	77
61	CAR	Ifugao	305182	Kiangan NHS	102
62	CAR	Kalinga	135978	Pantikian Elementary School	62
63	CAR	Kalinga	135986	Ubual Elementary School	70
64	CAR	Kalinga	136138	Buscalan Elementary School	65
65	CAR	Kalinga	220506	Roadside Elementary School	61
66	CAR	Kalinga	305227	Western Kalinga National High School	98
67	CAR	Mt. Province	136268	Banawel Elementary School	70
68	CAR	Mt. Province	136340	Sadanga Central School	64
69	CAR	Mt. Province	136353	Tanulong Elementary School	129
70	CAR	Mt. Province	136372	Masla Elementary School	77
71	CAR	Mt. Province	136374	Sayapot Elementary School	69
72	CAR	Mt. Province	136377	Tue Elementary School	72
73	CAR	Mt. Province	305240	Cagubatan National High School	115
74	CAR	Mt. Province	305242	Eastern Bontoc National Agricultural Vocational High School	79
75	CAR	Mt. Province	305260	Panabungen School of Arts, trades, and Home Industries	109
76	CAR	Mt. Province	305262	Pingad National High School	69
77	CAR	Mt. Province	319220	Anonat National Agricultural and Vocational High School	105
78	CAR	Tabuk City	136004	Casigayan Elementary School	62
79	CARAGA	Agusan del Norte	131512	Matabao Elementary School	68
80	CARAGA	Agusan del Norte	131556	Lombayan ES	70
81	CARAGA	Agusan del Norte	211509	Eliseo G. Alipao Elementary School	61
82	CARAGA	Agusan del Norte	304696	Nasipit National Vocational School	103
83	CARAGA	Agusan del Norte	304700	Tinigbasan NHS	68
84	CARAGA	Agusan del Norte	317314	Abilan Integrated School	75
85	CARAGA	Agusan del Norte	500311	Manoligao Elementary School	88
86	CARAGA	Agusan del Sur	131647	Agpan Elementary School	63
87	CARAGA	Agusan del Sur	131703	Guadalupe CES	78

No.	Region	Division	School ID	School Name	Sum of Total
88	CARAGA	Agusan del Sur	131766	Sabang Adgawan Elementary School	119
89	CARAGA	Agusan del Sur	131925	Malipayon ES	78
90	CARAGA	Agusan del Sur	131934	Sta. Josefa Central Elementary School with SPED Program	66
91	CARAGA	Agusan del Sur	131965	Santiago ES	62
92	CARAGA	Agusan del Sur	131983	La Flora Elementary School	126
93	CARAGA	Agusan del Sur	131989	Sabang Gibong ES	320
94	CARAGA	Agusan del Sur	212024	Mambagongon PS	200
95	CARAGA	Agusan del Sur	304703	Agusan del Sur National High School	63
96	CARAGA	Agusan del Sur	304714	Kasapa National High School	67
97	CARAGA	Agusan del Sur	304719	Loreto NHS	79
98	CARAGA	Agusan del Sur	304722	Lucena NHS	67
99	CARAGA	Agusan del Sur	304739	Laminga NHS	81
100	CARAGA	Agusan del Sur	304752	Talacogon National High School	71
101	CARAGA	Agusan del Sur	304755	Zillovia National High School	71
102	CARAGA	Agusan del Sur	317401	Panagangan NHS	109
103	CARAGA	Agusan del Sur	317408	Sinobong National High School	70
104	CARAGA	Agusan del Sur	317421	Johnson Nhs	130
105	CARAGA	Agusan del Sur	317423	Nato National High School	78
106	CARAGA	Agusan del Sur	317429	Novele National High School	78
107	CARAGA	Agusan del Sur	317437	Salvacion Nhs	702
108	CARAGA	Agusan del Sur	317446	San Vicente National High School	61
109	CARAGA	Agusan del Sur	500315	Maharlika ES	282
110	CARAGA	Bayugan City	131622	New Bohol Elementary School	62
111	CARAGA	Bislig City	132628	R. Castillo Elementary School	81
112	CARAGA	Bislig City	322505	Mabog National High School	61
113	CARAGA	Butuan City	132088	Dankias Elementary School	63
114	CARAGA	Butuan City	304756	Agusan National High School	76
115	CARAGA	Butuan City	304760	Bilay National High School	66
116	CARAGA	Dinagat Island	132367	Nueva Estrella Elementary School	65
117	CARAGA	Dinagat Island	132504	Ritaglenda Elementary School	94
118	CARAGA	Dinagat Island	132510	Tag-abaca Central Elementary School	83
119	CARAGA	Dinagat Island	304815	Cagdianao National High School	74
120	CARAGA	Dinagat Island	304851	Tag-abaca National High School	136
121	CARAGA	Dinagat Island	324407	Malinao National High School	82
122	CARAGA	Siargao	132124	Cabawa Elementary School	110
123	CARAGA	Siargao	132125	Can-uyan Primary School	71
124	CARAGA	Siargao	132127	Corregidor Elementary Schoo	109
125	CARAGA	Siargao	132129	Don Enrique Navarro Memorial School	82
126	CARAGA	Siargao	132130	Don Paulino Elementary School	66
127	CARAGA	Siargao	132132	Osmena Elementary School	73
128	CARAGA	Siargao	132141	New Uba Primary School	75
129	CARAGA	Siargao	132142	San Carlos Elementary School	69
130	CARAGA	Siargao	132166	Cancohay Elementary School	62
131	CARAGA	Siargao	132202	Sto. Nino Elementary School	63
132	CARAGA	Siargao	132221	Don. Albino Taruc Memorial ES	71

No.	Region	Division	School ID	School Name	Sum of Total
133	CARAGA	Siargao	132237	Salog Elementary School	64
134	CARAGA	Siargao	304774	Dapa National High School	62
135	CARAGA	Siargao	304778	Sta. Fe National High School	67
136	CARAGA	Siargao	304781	San Benito National High School	83
137	CARAGA	Surigao City	132275	Anomar Elementary School	75
138	CARAGA	Surigao City	132276	Arturo Borja ES	65
139	CARAGA	Surigao City	132289	B.Vasquez Memorial Central Elem. Sch.	71
140	CARAGA	Surigao City	132293	Ipil ES	67
141	CARAGA	Surigao City	132294	Josefa E. Fernandez Elementary School	76
142	CARAGA	Surigao City	132297	Mabua ES	80
143	CARAGA	Surigao City	132298	Margarita Mem. CES	66
144	CARAGA	Surigao City	304792	Juan P. Cedro Sr. Memorial High School	111
145	CARAGA	Surigao City	304793	Alegria National High School	121
146	CARAGA	Surigao City	304794	Caraga Regional Science High School	87
147	CARAGA	Surigao City	304801	Surigao City National High School	88
148	CARAGA	Surigao City	304802	Capalayan National High School	79
149	CARAGA	Surigao City	317703	Libuac National High School	442
150	CARAGA	Surigao City	317706	Manjagao National High School	323
151	CARAGA	Surigao City	340383	Cabrera-Altres National High School	85
152	CARAGA	Surigao del Norte	132331	Anao-aon CES	69
153	CARAGA	Surigao del Norte	132342	Bacuag CES	81
154	CARAGA	Surigao del Norte	132351	Pautao ES	87
155	CARAGA	Surigao del Norte	132352	Payapag Elementary School	66
156	CARAGA	Surigao del Norte	132404	Camam-onan ES	62
157	CARAGA	Surigao del Norte	132430	Cantugas Elementary School	81
158	CARAGA	Surigao del Norte	132434	Mainit CES	64
159	CARAGA	Surigao del Norte	132435	Mansayao ES	202
160	CARAGA	Surigao del Norte	132442	San Francisco ES	74
161	CARAGA	Surigao del Norte	132447	Tagbuyawan ES	184
162	CARAGA	Surigao del Norte	132459	Karihatag ES	79
163	CARAGA	Surigao del Norte	132463	Sohoton ES	72
164	CARAGA	Surigao del Norte	132526	Dakung Patag ES	86
165	CARAGA	Surigao del Norte	304814	Balite National High School	65
166	CARAGA	Surigao del Norte	304818	Cantapoy National High School	289
167	CARAGA	Surigao del Norte	304819	Pili National High School	137
168	CARAGA	Surigao del Norte	304820	Claver National High School	84
169	CARAGA	Surigao del Norte	304838	Lakandula National High School	140
170	CARAGA	Surigao del Norte	304855	Tubod National High School	88
171	CARAGA	Surigao del Norte	317808	Dakung Patag National High School	172
172	CARAGA	Surigao del Norte	317809	Talavera National High School	87
173	CARAGA	Surigao del Norte	317810	Cawilan National High School	68
174	CARAGA	Surigao del Sur	132666	Tigabong Elementary School	70
175	CARAGA	Surigao del Sur	132821	Bayogo Elementary School	71
176	CARAGA	Surigao del Sur	132864	Pongtod Elementary School	76
177	CARAGA	Surigao del Sur	132891	Umalag Elementary School	75

No.	Region	Division	School ID	School Name	Sum of Total
178	CARAGA	Surigao del Sur	132940	Caras-an Elementary School	65
179	CARAGA	Surigao del Sur	132949	Mga Bayani Ng Pilipinas Elementary School	65
180	CARAGA	Surigao del Sur	304861	Barobo National High School	61
181	CARAGA	Surigao del Sur	304896	M.K.Yusingco National High School	661
182	CARAGA	Surigao del Sur	304906	Bolhoon National High School	67
183	CARAGA	Surigao del Sur	304907	Sagbayan National High School	93
184	CARAGA	Surigao del Sur	317903	Badong National High School	72
185	CARAGA	Surigao del Sur	317913	San Roque National High School	62
186	CARAGA	Surigao del Sur	500574	Cabangahan Integrated School	102
187	CARAGA	Surigao del Sur	500581	Anibongan Integrated School	64
188	CARAGA	Tandag City	132957	Awasian Elementary School	105
189	CARAGA	Tandag City	132958	Banahao Elementary School	65
190	CARAGA	Tandag City	132959	Bioto Elementary School	80
191	CARAGA	Tandag City	132960	Bongtud Elementary School	71
192	CARAGA	Tandag City	132961	Buenavista Elementary School	65
193	CARAGA	Tandag City	132963	Salvacion Elementary School	64
194	CARAGA	Tandag City	132964	Engr. Nestor Ty Memorial Elementary School	66
195	CARAGA	Tandag City	132965	Hitaob Elementary School	89
196	CARAGA	Tandag City	132967	Mahanon Elementary School	111
197	CARAGA	Tandag City	132970	Pangi Elementary School	61
198	CARAGA	Tandag City	132971	Quezon Elementary School	94
199	CARAGA	Tandag City	132972	Quintos Elementary School	64
200	CARAGA	Tandag City	132975	San Antonio Elementary School	63
201	CARAGA	Tandag City	132976	SAN ISIDRO ELEMENTARY SCHOOL	65
202	CARAGA	Tandag City	132977	San Jose Elementary School	61
203	CARAGA	Tandag City	132978	Tandag Central Elementary School	63
204	CARAGA	Tandag City	132979	Tandag Pilot Elementary School	91
205	CARAGA	Tandag City	132980	Telaje Elementary School	64
206	CARAGA	Tandag City	214501	TANDAG CITY SPED CENTER	75
207	CARAGA	Tandag City	304871	Buenavista National High School	105
208	CARAGA	Tandag City	304922	Tandag National Science High School	114
209	CARAGA	Tandag City	500587	Carmen Integrated School	150
210	CARAGA	Tandag City	501274	Meliton M. Ajos Memorial Integrated School	78
211	NCR	Calocan City	305392	M. B. Asistio Sr. HS Unit 1	85
212	NCR	City of San Juan	136747	San Perfecto ES	73
213	NCR	Las Piñas City	136773	CAA Elementary School Main	100
214	NCR	Las Piñas City	136776	Ilaya Elementary School	63
215	NCR	Las Piñas City	136779	Pulanlupa Elementary School	70
216	NCR	Las Piñas City	136788	Pamplona Elementary School Unit I	68
217	NCR	Las Piñas City	305430	Las Piñas National High School	88
218	NCR	Las Piñas City	320304	Las Piñas City National Science High School	67
219	NCR	Malabon City	305447	Malabon National High School	79
220	NCR	Malabon City	500338	Col. Ramon Camus Integrated School	61
221	NCR	Mandaluyong City	500334	Jose Fabella Memorial School	97
222	NCR	Manila	136434	Gen. Vicente Lim Elementary School	70

No.	Region	Division	School ID	School Name	Sum of Total
223	NCR	Manila	136438	Magat Salamat Elementary School	91
224	NCR	Manila	305291	Tondo High School	244
225	NCR	Manila	305303	Raja Soliman Science and Technology High School	102
226	NCR	Manila	305308	Valeriano E. Fugoso Memorial High School	79
227	NCR	Manila	305309	M.Araullo High School	87
228	NCR	Manila	319401	Pres. Corazon C. Aquino High School	131
229	NCR	Marikina City	136682	H. Bautista ES	65
230	NCR	Marikina City	305399	Tañong HS	62
231	NCR	Marikina City	305401	Marikina Science HS	61
232	NCR	Marikina City	305402	Malanday National High School	84
233	NCR	Marikina City	319901	Nangka HS	73
234	NCR	Marikina City	319903	Barangka NHS	91
235	NCR	Marikina City	319906	Sto. Nino National High School	78
236	NCR	Marikina City	500052	Concepcion Integrated School	65
237	NCR	Muntinlupa City	305468	Muntinlupa NHS	96
238	NCR	Muntinlupa City	305469	Muntinlupa Science HS	96
239	NCR	Muntinlupa City	320704	Tunasan National HS	81
240	NCR	Muntinlupa City	500438	Lakeview Integrated School	74
241	NCR	Navotas	136868	Tangos I Elementary School	129
242	NCR	Navotas	136869	Tanza Elementary School	63
243	NCR	Navotas	136870	Wawa Elementary School	90
244	NCR	Navotas	305456	Kaunlaran High School	137
245	NCR	Paranaque City	136764	San Agustin Elementary School	64
246	NCR	Paranaque City	136770	Camp Claudio Elementary School	65
247	NCR	Paranaque City	305424	Paranaque National High School Main	77
248	NCR	Paranaque City	305426	Paranaque National High School - Baclaran	68
249	NCR	Paranaque City	320204	Sun Valley National High School	97
250	NCR	Paranaque City	320205	Don Bosco High School Paranaque	94
251	NCR	Pasay City	136592	Don Carlos Village ES	68
252	NCR	Pasay City	500328	Philippine National School for the Blind	191
253	NCR	Pasay City	500329	Philippine School for the Deaf	86
254	NCR	Pasig City	305413	Rizal High School	63
255	NCR	Pasig City	320102	Nagpayong High School	93
256	NCR	Quezon City	136497	Masambong Elementary School	126
257	NCR	Quezon City	136551	San Diego Elementary School	161
258	NCR	Quezon City	136584	Betty Go Belmonte ES	121
259	NCR	Quezon City	319501	Holy Spirit National High School	83
260	NCR	Taguig City and Pateros	305459	Bagumbayan National High School	91
261	NCR	Taguig City and Pateros	320607	Mayor Simplicio Manalo National HS	90
262	NCR	Valenzuela City	136802	Coloong Elementary School	67
263	NCR	Valenzuela City	136803	Isla Elementary School	103
264	NCR	Valenzuela City	136806	Pasolo Elementary School	62
265	NCR	Valenzuela City	136824	Doña Ata Elementary School	80
266	NCR	Valenzuela City	305436	Polo National High School	63
267	NCR	Valenzuela City	305437	Dalandanan National High School	104

No.	Region	Division	School ID	School Name	Sum of Total
268	NCR	Valenzuela City	305440	Lawang Bato National High School	124
269	NCR	Valenzuela City	305445	Caruhatan National High School	88
270	NCR	Valenzuela City	320401	Valenzuela City School of Mathematics and Science	65
271	NCR	Valenzuela City	320405	Arkong Bato National High School	78
272	Region I	Batac City	100078	Mariano Marcos Memorial Elementary School	66
273	Region I	Batac City	100080	Maipalig-Quiom ES	71
274	Region I	Candon City	300044	Candon National High School	68
275	Region I	Candon City	300051	Dr. Ricardo Gacula Memorial National High School	75
276	Region I	Dagupan City	102149	Juan L. Siapno ES	77
277	Region I	Dagupan City	102152	West Central Elementary School I	87
278	Region I	Dagupan City	102153	West CES II	62
279	Region I	Dagupan City	102154	Bacayao Sur ES	75
280	Region I	Dagupan City	102155	Caranglaan ES	68
281	Region I	Dagupan City	102158	Lasip Grande ES	68
282	Region I	Dagupan City	102160	Pogo-Lasip ES	94
283	Region I	Dagupan City	102162	BLISS ES	66
284	Region I	Dagupan City	102165	Bonuan Buquig ES	78
285	Region I	Dagupan City	102173	T. Ayson-Rosario ES	76
286	Region I	Dagupan City	102175	Carael ES	74
287	Region I	Dagupan City	102176	Lomboy ES	105
288	Region I	Dagupan City	102177	Pantal ES	103
289	Region I	Dagupan City	102179	Salapingao ES	88
290	Region I	Dagupan City	102180	Suit Elementary school	69
291	Region I	Dagupan City	300367	Bonuan Buquig NHS	131
292	Region I	Dagupan City	300368	Dagupan City NHS	84
293	Region I	Dagupan City	300369	Carael National HS	67
294	Region I	Dagupan City	300371	Judge Jose de Venecia, Sr. Technical-Vocational Secondary School	99
295	Region I	Dagupan City	500053	East Central Integrated School	86
296	Region I	Dagupan City	500054	Federico N. Ceralde Integrated School	85
297	Region I	Dagupan City	500055	Pugaro Integrated School	63
298	Region I	Ilocos Norte	100026	Badoc South Central School SPED Center	61
299	Region I	Ilocos Norte	100101	Agaga Elementary School	72
300	Region I	Ilocos Norte	100109	Tanap ES	95
301	Region I	Ilocos Norte	100115	Paguludan PS	76
302	Region I	Ilocos Norte	100116	Pangil ES	147
303	Region I	Ilocos Norte	100164	Burayoc ES	63
304	Region I	Ilocos Norte	100274	Bagbag ES	75
305	Region I	Ilocos Norte	100280	Maananteng ES	68
306	Region I	Ilocos Norte	100282	Nagpatpatan ES	88
307	Region I	Ilocos Norte	100286	Sta. Ana ES	67
308	Region I	Ilocos Norte	300003	Bangui NHS	70
309	Region I	Ilocos Norte	300006	Burgos Agro-Industrial School	86
310	Region I	Ilocos Norte	300017	Dumalneg NHS	74
311	Region I	Ilocos Norte	300018	Ilocos Norte Agricultural College	64
312	Region I	Ilocos Norte	300021	Nagrebcan NHS	115

No.	Region	Division	School ID	School Name	Sum of Total
313	Region I	Ilocos Norte	300025	Paoay Lake NHS	61
314	Region I	Ilocos Norte	300029	Sarrat National High School	78
315	Region I	Ilocos Norte	300031	VINTAR NHS	75
316	Region I	Ilocos Norte	320802	LANAO NATIONAL HIGH SCHOOL	79
317	Region I	Ilocos Norte	320815	Bingao National High School	68
318	Region I	Ilocos Norte	320820	Adriano P. Arzadon NHS	67
319	Region I	Ilocos Norte	320821	ISIC-ISIC NATIONAL HIGH SCHOOL	150
320	Region I	Ilocos Norte	500000	Caraitan Integrated School	61
321	Region I	Ilocos Norte	500345	Malaguip Integrated School	77
322	Region I	Ilocos Norte	500592	Pandan Integrated School	71
323	Region I	Ilocos Norte	500593	Sacritan Integrated School	62
324	Region I	Ilocos Norte	500594	Uguis Integrated School	100
325	Region I	Ilocos Sur	100342	Naonao Elementary School	60
326	Region I	Ilocos Sur	100365	San Emilio West Central School	60
327	Region I	Ilocos Sur	100381	Sallacong Elementary School	92
328	Region I	Ilocos Sur	100407	Catucdaan ES	79
329	Region I	Ilocos Sur	100424	Turod ES	61
330	Region I	Ilocos Sur	100453	Anonang-Naguilian Community School	92
331	Region I	Ilocos Sur	100457	Fuerte Elementary School	75
332	Region I	Ilocos Sur	100460	Puro Elementary School	65
333	Region I	Ilocos Sur	100461	Villamar Elementary School	146
334	Region I	Ilocos Sur	100528	Quinarayan Elementary School	71
335	Region I	Ilocos Sur	100541	Nagbukel CS	65
336	Region I	Ilocos Sur	100583	San Elias ES	71
337	Region I	Ilocos Sur	100723	Cabaritan Elementary School	63
338	Region I	Ilocos Sur	100740	Sto. Domingo North Central School	109
339	Region I	Ilocos Sur	300037	Banayoyo NHS	78
340	Region I	Ilocos Sur	300041	Burgos National High School	160
341	Region I	Ilocos Sur	300049	Dili NHS	76
342	Region I	Ilocos Sur	300055	Lipit NHS	71
343	Region I	Ilocos Sur	300056	Lussoc National High School	72
344	Region I	Ilocos Sur	300068	Puro NHS, Caoayan	65
345	Region I	Ilocos Sur	300076	San Pedro NHS	79
346	Region I	Ilocos Sur	300077	Santa Maria National High School	62
347	Region I	Ilocos Sur	300080	Sinait NHS	64
348	Region I	Ilocos Sur	300081	Solotsolot NHS	66
349	Region I	Ilocos Sur	500001	Sulvec Integrated School	77
350	Region I	Ilocos Sur	500346	Mabilbila Integrated School	84
351	Region I	La Union	101058	Sisi ES	60
352	Region I	La Union	101089	Ambitacay ES	68
353	Region I	La Union	101099	Narvacan ES	128
354	Region I	La Union	300094	Baccuit National High School	85
355	Region I	La Union	300097	Balbalayang National High School	60
356	Region I	La Union	300100	Bawanta National High School	63
357	Region I	La Union	300109	Damortis National High School	81

No.	Region	Division	School ID	School Name	Sum of Total
358	Region I	La Union	300112	Don Eulogio De Guzman Memorial NHS	109
359	Region I	La Union	300114	Dona Francisca Lacsamana de Ortega Memorial National High School	69
360	Region I	La Union	300119	Leones National High School	65
361	Region I	La Union	300121	Maoasoas National High School	88
362	Region I	La Union	300131	Pugo Central National High School	81
363	Region I	La Union	300135	San Gabriel Vocational High School	68
364	Region I	La Union	300139	Dr. Manuel T. Cases, Sr. National High School	124
365	Region I	La Union	300146	Sto. Rosario National High School	62
366	Region I	La Union	300148	Sudipen Vocational High School	63
367	Region I	La Union	300150	Tagudtud National High School	174
368	Region I	La Union	300151	Tanglag National High School	61
369	Region I	La Union	300152	Tubao National High School	107
370	Region I	La Union	300153	Wenceslao National High School	69
371	Region I	La Union	321007	Manga National High School	93
372	Region I	La Union	321010	Sto. Tomas National High School	65
373	Region I	La Union	500350	Baay Integrated School	72
374	Region I	La Union	500352	Dagup Integrated School	65
375	Region I	Laoag City	300375	Ilocos Norte Regional School of Fisheries	62
376	Region I	Laoag City	305601	Caoacan High School	67
377	Region I	Pangasinan I, Lingayen	101206	Batiarao Elementary School	72
378	Region I	Pangasinan I, Lingayen	101223	Abunciang Elementary School	81
379	Region I	Pangasinan I, Lingayen	101247	San Simon ES	90
380	Region I	Pangasinan I, Lingayen	101309	Baybay ES	131
381	Region I	Pangasinan I, Lingayen	101363	Samang Elementary School	64
382	Region I	Pangasinan I, Lingayen	101421	Cabilocan ES	68
383	Region I	Pangasinan I, Lingayen	101422	Calasiao Central School	60
384	Region I	Pangasinan I, Lingayen	101424	Nalsian Bacayao ES	65
385	Region I	Pangasinan I, Lingayen	101436	Macabito Elementary School	63
386	Region I	Pangasinan I, Lingayen	101438	Nagsaing Elementary School	115
387	Region I	Pangasinan I, Lingayen	101442	Bobonot ES	83
388	Region I	Pangasinan I, Lingayen	300159	Arnedo NHS	129
389	Region I	Pangasinan I, Lingayen	300163	Banaoang NHS	70
390	Region I	Pangasinan I, Lingayen	300177	Bued National High School	61
391	Region I	Pangasinan I, Lingayen	300193	Daniel Maramba NHS	67
392	Region I	Pangasinan I, Lingayen	300211	Lasip NHS	68
393	Region I	Pangasinan I, Lingayen	300218	Macarang National High School	74
394	Region I	Pangasinan I, Lingayen	300222	MANGATAREM NATIONAL HIGH SCHOOL	71
395	Region I	Pangasinan I, Lingayen	300225	Maticmatic National High School	71
396	Region I	Pangasinan I, Lingayen	300233	Pangasinan National High School	70
397	Region I	Pangasinan I, Lingayen	300235	Parayao National High School	63
398	Region I	Pangasinan I, Lingayen	300236	Urbiztondo National High School	68
399	Region I	Pangasinan I, Lingayen	300249	Sampaloc National High School	62
400	Region I	Pangasinan I, Lingayen	300257	Talospatang NHS	83
401	Region I	Pangasinan I, Lingayen	300259	Tanolong National High School	67
402	Region I	Pangasinan I, Lingayen	300263	Tococ National High School	65

No.	Region	Division	School ID	School Name	Sum of Total
403	Region I	Pangasinan I, Lingayen	500369	Ramon Magsaysay Integrated School	78
404	Region I	Pangasinan I, Lingayen	500604	Abagatanen Integrated School	77
405	Region I	Pangasinan I, Lingayen	500605	Aguilar Integrated School	68
406	Region I	Pangasinan I, Lingayen	500608	BANI EAST INTEGRATED SCHOOL	84
407	Region I	Pangasinan I, Lingayen	500614	Infanta Integrated School	80
408	Region I	Pangasinan I, Lingayen	500617	Paitan Integrated School	794
409	Region I	Pangasinan I, Lingayen	500621	Tupa Integrated School	64
410	Region I	Pangasinan II, Binalonan	101809	Bari ES	92
411	Region I	Pangasinan II, Binalonan	101828	Salay ES	106
412	Region I	Pangasinan II, Binalonan	101829	Talogtog ES	61
413	Region I	Pangasinan II, Binalonan	101878	Carmen Elementary School	74
414	Region I	Pangasinan II, Binalonan	101917	Tocok ES	60
415	Region I	Pangasinan II, Binalonan	101944	Bernabe Q. Biagtan ES	76
416	Region I	Pangasinan II, Binalonan	101967	Tacnien ES	60
417	Region I	Pangasinan II, Binalonan	102116	San Juan ES	68
418	Region I	Pangasinan II, Binalonan	500386	Lumayao Integrated School	71
419	Region I	Pangasinan II, Binalonan	300287	Benigno V. Aldana NHS	66
420	Region I	Pangasinan II, Binalonan	300292	Bulaoen East NHS	70
421	Region I	Pangasinan II, Binalonan	300294	Cabanbanan NHS	74
422	Region I	Pangasinan II, Binalonan	300295	Cabilaoan Agro-Industrial HS	68
423	Region I	Pangasinan II, Binalonan	300307	Juan G. Macaraeg NHS	104
424	Region I	Pangasinan II, Binalonan	300314	Guiling-Coliling NHS	60
425	Region I	Pangasinan II, Binalonan	300328	Mataas Na Paaralang Juan C. Laya	68
426	Region I	Pangasinan II, Binalonan	300340	Robert B. Estrella Memorial NHS	69
427	Region I	Pangasinan II, Binalonan	300349	San Juan NHS	70
428	Region I	Pangasinan II, Binalonan	300358	Sta. Maria NHS, Binalonan	81
429	Region I	Pangasinan II, Binalonan	300359	Sta. Maria NHS	74
430	Region I	Pangasinan II, Binalonan	500380	Dilan Integrated School	62
431	Region I	Pangasinan II, Binalonan	500388	Gueguesangen Integrated School	139
432	Region I	San Carlos City	300378	Bolingit National High School	123
433	Region I	San Carlos City	300379	Cobol National High School	65
434	Region I	San Carlos City	300382	Libas NATIONAL HIGH SCHOOL	60
435	Region I	San Carlos City	300384	Mabalbalino National High School	71
436	Region I	San Carlos City	300387	Salinap National High School	62
437	Region I	San Fernando City	101044	San Agustin (Poro) Elementary School	74
438	Region I	San Fernando City	300116	Dr. Quintin Balcita Sr. NHS	104
439	Region I	San Fernando City	300118	La Union NHS	125
440	Region I	Urdaneta City	102301	Manan Elementary School	63
441	Region I	Urdaneta City	102305	Pinmaludpod Elementary School	82
442	Region I	Urdaneta City	102306	San Jose Elementary School	71
443	Region I	Urdaneta City	300399	Casabula National High School	63
444	Region I	Urdaneta City	500007	Catablan Integrated School	74
445	Region I	Vigan City	300089	Vigan West National High School	83
446	Region II	Batanes	300414	Itbayat National Agricultural HS	109
447	Region II	Batanes	500063	Raele Integrated School	64

No.	Region	Division	School ID	School Name	Sum of Total
448	Region II	Cagayan	102341	Libertad Elementary School	66
449	Region II	Cagayan	102342	Lucban ES	71
450	Region II	Cagayan	102419	Agguirit Elementary School	94
451	Region II	Cagayan	102444	Gaddang ES	66
452	Region II	Cagayan	102449	Punta Elementary School	470
453	Region II	Cagayan	102494	Marus ES	70
454	Region II	Cagayan	102496	Pallagao ES	124
455	Region II	Cagayan	102585	Camiguin ES	64
456	Region II	Cagayan	102643	Abra Elementary	106
457	Region II	Cagayan	102694	CASITAN E/S	82
458	Region II	Cagayan	102748	Magapit ES	60
459	Region II	Cagayan	102798	Buyun ES	62
460	Region II	Cagayan	102841	Masi Elementary School	74
461	Region II	Cagayan	102864	Taguiporo ES	118
462	Region II	Cagayan	102889	Nangalisan ES	60
463	Region II	Cagayan	102971	San Vicente Elementary School	79
464	Region II	Cagayan	155008	Rissic ES	61
465	Region II	Cagayan	155040	Bibigsan PS	64
466	Region II	Cagayan	300421	Alcala Rural School	161
467	Region II	Cagayan	300423	Alig Valley National High School	88
468	Region II	Cagayan	300426	Andarayan NHS	77
469	Region II	Cagayan	300428	Aparri School of Arts and Trades	71
470	Region II	Cagayan	300436	Bidduang National High School	60
471	Region II	Cagayan	300437	Bukig National Agricultural and Technical School	114
472	Region II	Cagayan	300451	Claveria SAT	92
473	Region II	Cagayan	300456	Don Severino Pagalilauan National High School	174
474	Region II	Cagayan	300461	Gadu National High School	90
475	Region II	Cagayan	300464	Illuru NHS	112
476	Region II	Cagayan	300485	Sanchez Mira NHS	69
477	Region II	Cagayan	300490	Sta. Teresita National High School	66
478	Region II	Cagayan	306004	Magapit NHS	71
479	Region II	Cagayan	306010	PACAC GRANDE NAT'L. HIGH SCHOOL	66
480	Region II	Cagayan	500009	Utan IS	124
481	Region II	Cagayan	500064	Babuyan Claro IS	73
482	Region II	Cauayan City	103211	Cauayan North CS	71
483	Region II	Cauayan City	103213	Dabburab-Baringin ES	68
484	Region II	City of Ilagan	500731	Sindun Bayabo IS	63
485	Region II	Isabela	103016	San Pablo Elementary School	118
486	Region II	Isabela	300522	Cabagan Riverside National High School	101
487	Region II	Isabela	300554	Isabela School of Fisheries	61
488	Region II	Isabela	300568	Quezon National High School	75
489	Region II	Isabela	300581	Salinungan National High School	73
490	Region II	Isabela	300593	Alibadabad National High School	72
491	Region II	Isabela	300601	St. Paul Vocational and Industrial High School	109
492	Region II	Isabela	300612	Echague National High School	82

No.	Region	Division	School ID	School Name	Sum of Total
493	Region II	Isabela	500082	Sto. Domingo Integrated School	63
494	Region II	Nueva Vizcaya	103975	Macate ES	180
495	Region II	Nueva Vizcaya	104213	Bintawan North Elementary School	70
496	Region II	Nueva Vizcaya	300615	Alfonso Castañeda NHS	94
497	Region II	Nueva Vizcaya	300617	Ambaguio High School	69
498	Region II	Nueva Vizcaya	500895	Binalian ES	76
499	Region II	Quirino	104340	Sto. Niño ES	70
500	Region II	Quirino	500106	Giayan IS	61
501	Region II	Santiago City	300505	Cabulay High School	71
502	Region II	Santiago City	306124	Patul National High School	73
503	Region II	Santiago City	325203	Rosario National High School	73
504	Region II	Tuguegarao City	104406	Tuguegarao West CS	79
505	Region II	Tuguegarao City	300670	Linao National High School	73
506	Region II	Tuguegarao City	300671	Gosi National High School	62
507	Region II	Tuguegarao City	306401	Tuguegarao City Science High School	79
508	Region III	Angeles City	301039	Angeles City NHS	63
509	Region III	Angeles City	307201	Rafael L. Lazatin Mem. HS	73
510	Region III	Angeles City	307203	Claro M. Recto ICT High School	76
511	Region III	Balanga City	104561	M. Delos Reyes Memorial Elementary School	62
512	Region III	Balanga City	104562	Puerto Rivas Elementary School	87
513	Region III	Balanga City	300702	Bataan National High School	93
514	Region III	Balanga City	322901	City of Balanga National High School	122
515	Region III	Bataan	104578	Kataasan ES	66
516	Region III	Bataan	104604	Almacen ES	79
517	Region III	Bataan	104610	Hermosa ES	61
518	Region III	Bataan	104624	St. Francis ES (Bacong)	68
519	Region III	Bataan	104651	Kanawan Integrated School	72
520	Region III	Bataan	104660	Kabalutan ES	64
521	Region III	Bataan	104663	Orani North ES	64
522	Region III	Bataan	300703	Bataan School of Fisheries	131
523	Region III	Bataan	500119	Biaan Aeta IS	83
524	Region III	Bulacan	104759	Tiaong ES	63
525	Region III	Bulacan	104761	Bambang ES	92
526	Region III	Bulacan	104764	Bunducan ES	71
527	Region III	Bulacan	104768	Lolomboy ES	89
528	Region III	Bulacan	104780	Sta. Ana ES	78
529	Region III	Bulacan	104803	Arsenio Santos Memorial Elementary School	82
530	Region III	Bulacan	104836	Hagonoy Cs	135
531	Region III	Bulacan	104848	Don Miguel ES	125
532	Region III	Bulacan	104849	Hagonoy West Central School	196
533	Region III	Bulacan	104850	Mercado ES	68
534	Region III	Bulacan	104851	Pugad ES	217
535	Region III	Bulacan	104853	San Jose ES	137
536	Region III	Bulacan	104855	San Pascual Elementary School	79
537	Region III	Bulacan	104857	Sta. Elena ES	147

No.	Region	Division	School ID	School Name	Sum of Total
538	Region III	Bulacan	104861	Victoriano C. Raymundo Elementary School	215
539	Region III	Bulacan	104961	Binuangan ES	96
540	Region III	Bulacan	104964	Obando Central School	71
541	Region III	Bulacan	104966	Panghulo Elementary School	61
542	Region III	Bulacan	104989	LANTAD ES	60
543	Region III	Bulacan	104990	Masukol ES	238
544	Region III	Bulacan	104996	Sta. Cruz ES	131
545	Region III	Bulacan	105092	Bagong Silang E/S	65
546	Region III	Bulacan	105108	Salacot ES	61
547	Region III	Bulacan	105164	San Vicente Elementary School	88
548	Region III	Bulacan	158530	Salambao Elementary School	207
549	Region III	Bulacan	300721	Balagtas National Agricultural HS	426
550	Region III	Bulacan	300728	Bunsuran NHS	67
551	Region III	Bulacan	300732	San Ildefonso National High School	332
552	Region III	Bulacan	300736	Sta. Lucia National High School	75
553	Region III	Bulacan	300740	ASSEMBLYWOMAN FELICITA G. BERNARDINO MEMORIAL TRADE SCHOOL	75
554	Region III	Bulacan	300747	Taal High School	71
555	Region III	Bulacan	300754	Ramona S. Trillana HS (Mayor Ramon Trillana Mem. HS (Iba NHS))	121
556	Region III	Bulacan	300756	Sta. Monica National High School	77
557	Region III	Bulacan	300763	Obando NHS	62
558	Region III	Bulacan	300764	Obando School of Fisheries	326
559	Region III	Bulacan	300771	San Miguel NHS	423
560	Region III	Bulacan	300776	Sta. Cruz NHS	154
561	Region III	Bulacan	300781	Aguinaldo J. Santos National High School	89
562	Region III	Bulacan	305693	GAT Francisco Balagtas High School	198
563	Region III	Bulacan	305865	Gabihan High School	149
564	Region III	Bulacan	306707	Angel M. del Rosario High School	207
565	Region III	Bulacan	306723	San Miguel-Meysulao High School	63
566	Region III	Cabanatuan City	107067	J.P. Melencio Memorial Elementary School	121
567	Region III	City of San Jose Del Monte	107158	Muzon (Pabahay 2000) Elementary School	79
568	Region III	City of San Jose Del Monte	301060	San Jose Del Monte National HS	91
569	Region III	Gapan City	105337	Parcutela ES	62
570	Region III	Gapan City	300851	San Roque NHS	80
571	Region III	Mabalacat City	306909	Mabalacat Technical Vocational High School	68
572	Region III	Malolos City	104867	Caingin ES	131
573	Region III	Malolos City	104886	Bagna ES	139
574	Region III	Malolos City	104889	Canalate ES	76
575	Region III	Malolos City	300751	Marcelo H. del Pilar National HS	62
576	Region III	Malolos City	323601	Bulihan NHS	82
577	Region III	Malolos City	500404	CITY OF MALOLOS INTEGRATED SCHOOL - ATLAG	63
578	Region III	Meycauayan City	500439	Bancal Integrated School	65
579	Region III	Nueva Ecija	105483	San Casimiro ES	64
580	Region III	Nueva Ecija	105623	Pulong Bahay Elementary School	69
581	Region III	Nueva Ecija	105664	Lawang Kupang ES	62
582	Region III	Nueva Ecija	105669	Papaya ES	84

No.	Region	Division	School ID	School Name	Sum of Total
583	Region III	Nueva Ecija	105768	Baloc ES	70
584	Region III	Nueva Ecija	105846	Talugtug East CS	104
585	Region III	Nueva Ecija	105860	Mayamot ES	76
586	Region III	Nueva Ecija	159004	Pagsangjan Elementary School	73
587	Region III	Nueva Ecija	159016	Felicidad V. Buendia ES	62
588	Region III	Nueva Ecija	300802	Dofia Juana Chioco National High School	130
589	Region III	Nueva Ecija	300816	Macabaclay National High School	68
590	Region III	Nueva Ecija	300838	Nampicuan NHS	74
591	Region III	Nueva Ecija	300841	Rizal National High School	99
592	Region III	Nueva Ecija	306830	Cambitala NHS	62
593	Region III	Olongapo City	107124	Olongapo City ES	67
594	Region III	Olongapo City	107136	Nellie E. Brown Elementary School	65
595	Region III	Pampanga	106090	Batasan ES	86
596	Region III	Pampanga	106096	San Roque ES	69
597	Region III	Pampanga	106103	Castuli ES	65
598	Region III	Pampanga	106104	Consuelo Elementary	65
599	Region III	Pampanga	106108	San Esteban ES	135
600	Region III	Pampanga	106113	Sta. Lutgarda ES	63
601	Region III	Pampanga	106114	Sta. Maria CS	96
602	Region III	Pampanga	106133	San Pedro II ES	65
603	Region III	Pampanga	106145	Balibago ES	67
604	Region III	Pampanga	106150	Cambasi Elementary School	122
605	Region III	Pampanga	106152	Masantol ES	60
606	Region III	Pampanga	106154	Palimpe ES	65
607	Region III	Pampanga	106156	San Isidro ES	123
608	Region III	Pampanga	106159	Sta. Cruz ES (Main)	60
609	Region III	Pampanga	106216	Camias ES	61
610	Region III	Pampanga	106269	Malusac ES	66
611	Region III	Pampanga	106278	Fulgencio Matias Elem. School	68
612	Region III	Pampanga	106298	Moras Dela Paz ES	71
613	Region III	Pampanga	159531	Sagrada Familia ES	60
614	Region III	Pampanga	300878	Baruya NHS	63
615	Region III	Pampanga	300882	Betis NHS	61
616	Region III	Pampanga	300883	Caduang Tete HS	100
617	Region III	Pampanga	300891	Guillermo D. Mendoza NHS	74
618	Region III	Pampanga	300897	Malusac NHS	144
619	Region III	Pampanga	300899	Mapaniqui NHS	60
620	Region III	Pampanga	300915	San Esteban NHS	93
621	Region III	Pampanga	300921	San Juan NHS, Mexico	63
622	Region III	Pampanga	300924	San Matias NHS	81
623	Region III	Pampanga	300930	San Vicente-San Francisco NHS	104
624	Region III	Pampanga	300934	Sta. Maria NHS, Macabebe	168
625	Region III	Pampanga	300936	Sto. Rosario NHS	67
626	Region III	Pampanga	300941	Telacsan NHS	65
627	Region III	Pampanga	306926	Malauli High School	99

No.	Region	Division	School ID	School Name	Sum of Total
628	Region III	Pampanga	306937	Dalayap High School	134
629	Region III	San Fernando City	301064	Pampanga High School	61
630	Region III	San Fernando City	301066	Sindalan National High School	62
631	Region III	San Fernando City	307603	Panipuan High School	70
632	Region III	San Fernando City	500137	Nuestra Senora Del Pilar Integrated School	74
633	Region III	San Fernando City	500140	Baliti Integrated School	74
634	Region III	San Fernando City	500145	Maimpis Integrated School	108
635	Region III	San Fernando City	500146	Calulut Integrated School	83
636	Region III	San Fernando City	500150	Sta. Lucia Integrated School	90
637	Region III	San Jose City	105710	San Juan Elementary School	71
638	Region III	San Jose City	105711	Ciriaco Esteban Elementary School (formerly Sto. Niño 1st Elementary School)	61
639	Region III	San Jose City	105724	Parang Mangga Elementary School	60
640	Region III	Tarlac	106310	Anupul ES	71
641	Region III	Tarlac	106483	San Jose ES	72
642	Region III	Tarlac	106485	Villa Paz ES	62
643	Region III	Tarlac	106505	San Isidro CES	64
644	Region III	Tarlac	106532	Moncada North CS	66
645	Region III	Tarlac	106545	Burgos ES	63
646	Region III	Tarlac	106558	Aduas ES	77
647	Region III	Tarlac	106559	Apulid ES	61
648	Region III	Tarlac	106561	Baltazar ES	78
649	Region III	Tarlac	106564	Cojuangco ES	82
650	Region III	Tarlac	106669	Caduldulaoan Elementary School	70
651	Region III	Tarlac	300956	Calangitan HS (Resettlement School)	67
652	Region III	Tarlac	300959	Cardona NHS	79
653	Region III	Tarlac	300963	Dueg High School	169
654	Region III	Tarlac	300966	Guevara NHS	117
655	Region III	Tarlac	300974	Maungib NHS	74
656	Region III	Tarlac	300994	Capas National High School	64
657	Region III	Tarlac City	300944	Alvindia-Aguso National High School	101
658	Region III	Tarlac City	300970	Maliwalo NHS	82
659	Region III	Zambales	106805	Loob-Bunga III Elementary School	91
660	Region III	Zambales	106826	Cabangan Elementary School	190
661	Region III	Zambales	106835	San Rafael Elementary School	87
662	Region III	Zambales	106872	Dirita-Baloguen Elementary School	71
663	Region III	Zambales	106876	Lipay-Dingin Elementary School	84
664	Region III	Zambales	106984	Pagatpat Elementary School	83
665	Region III	Zambales	107018	SAN ISIDRO ELEMENTARY SCHOOL	60
666	Region III	Zambales	160502	ADBSA Aeta School (Jesmag Iba)	61
667	Region III	Zambales	160503	Chiang Chio Te Mem. Aeta School (Ibad PS)	64
668	Region III	Zambales	160511	Manggahan Elementary School	81
669	Region III	Zambales	160523	Burgos Elementary School	80
670	Region III	Zambales	301003	Acoje National High School	95
671	Region III	Zambales	301019	Lauis National High School	72
672	Region III	Zambales	301021	Gov. Manuel D. Barretto National High School	112

No.	Region	Division	School ID	School Name	Sum of Total
673	Region III	Zambales	301025	Botolan National High School	105
674	Region III	Zambales	301028	Locloc National High School	70
675	Region III	Zambales	301035	Sta. Fe NHS	186
676	Region III	Zambales	301036	Subic National High School	155
677	Region III	Zambales	307103	San Salvador High School	95
678	Region III	Zambales	307107	San Antonio National High School	62
679	Region III	Zambales	307117	Pundakit High School	83
680	Region III	Zambales	307122	San Rafael High School	205
681	Region IV-A	Antipolo City	109321	Bagong Nayon IV ES	61
682	Region IV-A	Antipolo City	109322	Libis ES	63
683	Region IV-A	Antipolo City	109332	Muntindilaw ES	85
684	Region IV-A	Antipolo City	301421	Kaysakat NHS	93
685	Region IV-A	Antipolo City	301422	Mayamot NHS	127
686	Region IV-A	Antipolo City	301423	Muntindilaw NHS	127
687	Region IV-A	Antipolo City	301425	San Roque NHS	63
688	Region IV-A	Antipolo City	301426	San Isidro NHS	75
689	Region IV-A	Antipolo City	301431	Calawis NHS	72
690	Region IV-A	Antipolo City	321501	Marcelino M. Santos NHS	141
691	Region IV-A	Antipolo City	321502	Canumay NHS	60
692	Region IV-A	Antipolo City	321504	Rizza NHS	70
693	Region IV-A	Antipolo City	321506	Dalig NHS	98
694	Region IV-A	Bacoor City	107867	Bacoor Elementary School	89
695	Region IV-A	Bacoor City	107868	Digman Elementary School	75
696	Region IV-A	Bacoor City	107869	Dulong Bayan Elementary School	77
697	Region IV-A	Bacoor City	107870	Habay Elementary School	62
698	Region IV-A	Bacoor City	107871	Mabolo Elementary School	85
699	Region IV-A	Bacoor City	107872	Maliksi Elementary School	73
700	Region IV-A	Bacoor City	107873	Mambog Elementary School	98
701	Region IV-A	Bacoor City	107874	Real Elementary School	68
702	Region IV-A	Bacoor City	107875	Salinas Elementary School	87
703	Region IV-A	Bacoor City	107876	Sineguelasan Elementary School	116
704	Region IV-A	Bacoor City	107877	Aniban Central School	84
705	Region IV-A	Bacoor City	107879	Gawaran Elementary School	68
706	Region IV-A	Bacoor City	107880	Gov. P. F. Espiritu Elementary School	113
707	Region IV-A	Bacoor City	107881	Ligas I Elementary School	94
708	Region IV-A	Bacoor City	107884	Longos Elementary School	77
709	Region IV-A	Bacoor City	107885	Malipay Elementary School	73
710	Region IV-A	Bacoor City	107887	Niog Elementary School	66
711	Region IV-A	Bacoor City	107888	Queens Row Elementary School	63
712	Region IV-A	Bacoor City	107889	San Nicolas Elementary School	75
713	Region IV-A	Bacoor City	107890	Talaba Elementary School	72
714	Region IV-A	Bacoor City	164009	Poblacion Elementary School	63
715	Region IV-A	Bacoor City	301188	Eastern Bacoor National High School	68
716	Region IV-A	Batangas	107201	Bernardo Ondo Memorial Elementary School	107
717	Region IV-A	Batangas	107202	Agoncillo Central School	112

No.	Region	Division	School ID	School Name	Sum of Total
718	Region IV-A	Batangas	107203	Pamiga Elementary School	107
719	Region IV-A	Batangas	107204	Balangon Elementary School	115
720	Region IV-A	Batangas	107205	Banyaga Elementary School	109
721	Region IV-A	Batangas	107206	Barigon Elementary School	112
722	Region IV-A	Batangas	107207	Bilibinwang Elementary School	111
723	Region IV-A	Batangas	107208	Coral na Munti Elementary School	111
724	Region IV-A	Batangas	107209	Mahabang Gulod Elementary School	112
725	Region IV-A	Batangas	107210	Panhulan Elementary School	94
726	Region IV-A	Batangas	107211	Pansipit Elementary School	112
727	Region IV-A	Batangas	107212	Pook Elementary School	109
728	Region IV-A	Batangas	107213	Subic Elementary School	129
729	Region IV-A	Batangas	107226	Balayan West Central School	251
730	Region IV-A	Batangas	107230	Troadio A. Frontera Memorial Elementary School	68
731	Region IV-A	Batangas	107232	Dao Elementary School	67
732	Region IV-A	Batangas	107249	Juan C. De Lunas Memorial Elementary School	60
733	Region IV-A	Batangas	107276	San Andres Elementary School	66
734	Region IV-A	Batangas	107295	Lumbang Calzada Elementary School	70
735	Region IV-A	Batangas	107312	Timbain School	103
736	Region IV-A	Batangas	107314	Balibago Elementary School	61
737	Region IV-A	Batangas	107315	Santiago Zobel Elementary School	70
738	Region IV-A	Batangas	107316	Jose M. Caisip Elementary School	74
739	Region IV-A	Batangas	107317	Bucal Elementary School	74
740	Region IV-A	Batangas	107318	Calambuyan Elementary School	77
741	Region IV-A	Batangas	107319	Jacobo Zobel Elementary School	94
742	Region IV-A	Batangas	107320	Carlota Elementary School	77
743	Region IV-A	Batangas	107321	Carretonan Elementary School	89
744	Region IV-A	Batangas	107323	Gulod Elementary School	73
745	Region IV-A	Batangas	107325	Kilitisan Elementary School	66
746	Region IV-A	Batangas	107326	Paraiso Elementary School	76
747	Region IV-A	Batangas	107327	Angelita Zobel Elementary School	87
748	Region IV-A	Batangas	107328	Luya Elementary School	61
749	Region IV-A	Batangas	107329	Pedro Palacio Sr. Memorial Elementary School	103
750	Region IV-A	Batangas	107331	Enrique Zobel Elementary School	78
751	Region IV-A	Batangas	107332	Florencio D. Firmante Elementary School	64
752	Region IV-A	Batangas	107333	Talisay Elementary School	66
753	Region IV-A	Batangas	107334	Tanagan Elementary School	81
754	Region IV-A	Batangas	107367	As-Is Elementary School	80
755	Region IV-A	Batangas	107369	Berinayan Elementary School	106
756	Region IV-A	Batangas	107370	Bignay Elementary School	102
757	Region IV-A	Batangas	107372	Buso-Buso Elementary School	84
758	Region IV-A	Batangas	107373	Gulod Elementary School	167
759	Region IV-A	Batangas	107374	Laurel Central School	85
760	Region IV-A	Batangas	107375	Leviste Elementary School	107
761	Region IV-A	Batangas	107376	Molinete Elementary School	102
762	Region IV-A	Batangas	107377	Niyugan Elementary School	110

No.	Region	Division	School ID	School Name	Sum of Total
763	Region IV-A	Batangas	107378	Paliparan Elementary School	74
764	Region IV-A	Batangas	107379	Pantay Elementary School	82
765	Region IV-A	Batangas	107380	San Gabriel Elementary School	111
766	Region IV-A	Batangas	107383	Sta. Maria Elementary School	105
767	Region IV-A	Batangas	107388	Mayasang Elementary School	90
768	Region IV-A	Batangas	107391	Sinisian Elementary School	113
769	Region IV-A	Batangas	107393	Tubuan Elementary School	68
770	Region IV-A	Batangas	107394	V. Ornales Memorial Elementary School	104
771	Region IV-A	Batangas	107401	Bungahan Elementary School	73
772	Region IV-A	Batangas	107403	Dayapan Elementary School	115
773	Region IV-A	Batangas	107409	Lemery Pilot Elementary School	62
774	Region IV-A	Batangas	107412	Luyahan Elementary School	63
775	Region IV-A	Batangas	107416	Matabungkay Elementary School	66
776	Region IV-A	Batangas	107420	Prenza Elementary School	68
777	Region IV-A	Batangas	107422	San Diego Elementary School	79
778	Region IV-A	Batangas	107424	San Isidro Labac Elementary School	65
779	Region IV-A	Batangas	107425	Tanag Elementary School	68
780	Region IV-A	Batangas	107450	Bagalangit Elementary School	69
781	Region IV-A	Batangas	107468	Bilucao Elementary School	70
782	Region IV-A	Batangas	107497	Bulihan Elementary School	94
783	Region IV-A	Batangas	107643	Bonliw Elementary School	103
784	Region IV-A	Batangas	107649	Mahabang Parang Elementary School	76
785	Region IV-A	Batangas	107650	Muzon Elementary School	76
786	Region IV-A	Batangas	107651	San Antonio Elementary School	95
787	Region IV-A	Batangas	107657	Tungal Elementary School	74
788	Region IV-A	Batangas	107687	Burol Elementary School	70
789	Region IV-A	Batangas	107807	Banalo Elementary School	70
790	Region IV-A	Batangas	107808	Corona Elementary School	66
791	Region IV-A	Batangas	107809	Gamaw Elementary School	66
792	Region IV-A	Batangas	107811	Marikaban Elementary School	65
793	Region IV-A	Batangas	107815	San Juan Elementary School	72
794	Region IV-A	Batangas	107820	Tingloy Central School	64
795	Region IV-A	Batangas	107838	Toong Elementary School	64
796	Region IV-A	Batangas	163507	Sucol Elementary School	62
797	Region IV-A	Batangas	163517	Martin Esperanza Elementary School	79
798	Region IV-A	Batangas	301072	Balayan National High School	63
799	Region IV-A	Batangas	301074	Banilad National High School	79
800	Region IV-A	Batangas	301076	Banyaga National High School	103
801	Region IV-A	Batangas	301080	Bauan Technical Integrated High School	74
802	Region IV-A	Batangas	301083	Bayorbor National High School	353
803	Region IV-A	Batangas	301086	Bilaran National High School	94
804	Region IV-A	Batangas	301095	Coral na Munti National High School	136
805	Region IV-A	Batangas	301107	Kaylaway National High School	74
806	Region IV-A	Batangas	301109	Looc National High School	84
807	Region IV-A	Batangas	301112	Lumbangan National High School	72

No.	Region	Division	School ID	School Name	Sum of Total
808	Region IV-A	Batangas	301120	Malapad na Bato National High School	104
809	Region IV-A	Batangas	301131	Palakpak Integrated National High School	63
810	Region IV-A	Batangas	301134	Papaya National High School	64
811	Region IV-A	Batangas	301152	Tala National High School	108
812	Region IV-A	Batangas	301160	Tipas Integrated National High School	116
813	Region IV-A	Batangas	301162	Tumalim National High School	109
814	Region IV-A	Batangas	301164	Wenceslao Trinidad Memorial National High School	82
815	Region IV-A	Batangas	305481	Lemery Senior High School	87
816	Region IV-A	Batangas	307705	Agoncillo National High School	109
817	Region IV-A	Batangas	307706	Lian National High School	75
818	Region IV-A	Batangas	307714	Dr. Bonifacio A. Masilungan Integrated National High School	73
819	Region IV-A	Batangas	307723	Catandaan Yabut National High School	68
820	Region IV-A	Batangas	307728	Angeles Luistro Integrated Senior High School	68
821	Region IV-A	Batangas	342197	Tala Senior High School	86
822	Region IV-A	Batangas	342203	Mataasnakahoy Senior High School	119
823	Region IV-A	Batangas	342204	Placido T. Amo Senior High School	91
824	Region IV-A	Batangas	342216	Agoncillo Senior High School	91
825	Region IV-A	Batangas	501011	San Gregorio Integrated School	171
826	Region IV-A	Batangas	501014	Balakilong Integrated School	185
827	Region IV-A	Batangas	501540	Luya Integrated School	82
828	Region IV-A	Batangas	501541	Sampa-Pacifico Integrated School (K TO 12)	84
829	Region IV-A	Batangas City	109580	Tibig ES	106
830	Region IV-A	Batangas City	301470	Balete Integrated School	124
831	Region IV-A	Batangas City	301471	Banaba West Integrated School	67
832	Region IV-A	Batangas City	301476	Pinamukan Integrated School	72
833	Region IV-A	Batangas City	301481	Tabangao Integrated School	73
834	Region IV-A	Binan City	108218	Dela Paz West ES	70
835	Region IV-A	Cabuyao City	301234	Cabuyao Integrated National High School	77
836	Region IV-A	Cabuyao City	307923	Southville I Integrated National High School	140
837	Region IV-A	Calamba City	109814	Bucal Elementary School	79
838	Region IV-A	Calamba City	109815	E. Barretto Sr. Elementary School	71
839	Region IV-A	Calamba City	109817	Jose Rizal MS	67
840	Region IV-A	Calamba City	109824	Ronggot Elementary School	69
841	Region IV-A	Calamba City	109828	Banlic Elementary School	60
842	Region IV-A	Calamba City	109829	Calamba Elementary School	63
843	Region IV-A	Calamba City	109830	Crossing ES	62
844	Region IV-A	Calamba City	109831	Halang Elementary School	63
845	Region IV-A	Calamba City	109834	Palingon ES	68
846	Region IV-A	Calamba City	109836	Sampiruhan Elementary School	65
847	Region IV-A	Calamba City	109837	San Cristobal Elementary School	118
848	Region IV-A	Calamba City	109840	Bubuyan Elementary School	64
849	Region IV-A	Calamba City	109846	Laguerta ES	61
850	Region IV-A	Calamba City	109852	Mangumit ES	62
851	Region IV-A	Calamba City	109854	Mayapa Elementary School	68
852	Region IV-A	Calamba City	109861	San Ramon Elementary School	60

No.	Region	Division	School ID	School Name	Sum of Total
853	Region IV-A	Calamba City	301511	Bubuyan Integrated School	83
854	Region IV-A	Calamba City	301512	Bunggo NHS	68
855	Region IV-A	Calamba City	301514	Calamba Bayside Integrated School	98
856	Region IV-A	Calamba City	301515	Calamba Integrated School	112
857	Region IV-A	Calamba City	301516	Camp Vicente Lim Integrated School	83
858	Region IV-A	Calamba City	301519	Looc Integrated School	94
859	Region IV-A	Calamba City	301521	Kapayapaan Integrated School	99
860	Region IV-A	Calamba City	301522	Majada In Integrated School	74
861	Region IV-A	Calamba City	301523	Makiling Integrated School	108
862	Region IV-A	Calamba City	301524	Palo Alto Integrated School	83
863	Region IV-A	Calamba City	301525	Punta Integrated School	101
864	Region IV-A	Calamba City	308701	Integrated School of Lawa	109
865	Region IV-A	Calamba City	308702	Lecheria Integrated School	61
866	Region IV-A	Calamba City	308704	Calamba City Science Integrated School	70
867	Region IV-A	Cavite	107866	Tamakan Elementary School	62
868	Region IV-A	Cavite	107926	Bailen Elementary School	85
869	Region IV-A	Cavite	107927	Castaños Elementary School	89
870	Region IV-A	Cavite	107928	Dao Elementary School	79
871	Region IV-A	Cavite	107929	Guyung-Guyong Elementary School	80
872	Region IV-A	Cavite	107930	Kabulusan Elementary School	82
873	Region IV-A	Cavite	107931	Kaymiskas Elementary School	75
874	Region IV-A	Cavite	107932	Kaypaaba Elementary School	84
875	Region IV-A	Cavite	107933	Lumipa Elementary School	85
876	Region IV-A	Cavite	107934	Narvaez Elementary School	92
877	Region IV-A	Cavite	107935	Tabora Elementary School	85
878	Region IV-A	Cavite	107940	San Gabriel I Elementary School	69
879	Region IV-A	Cavite	107993	Guyam Munti Elementary School	63
880	Region IV-A	Cavite	108020	Gahak-Marulas Elementary School	61
881	Region IV-A	Cavite	108022	Panamitan Elementary School	82
882	Region IV-A	Cavite	108027	Baliwag Elementary School	98
883	Region IV-A	Cavite	108028	Bendita Elementary School	90
884	Region IV-A	Cavite	108029	Cabulusan Elementary School	94
885	Region IV-A	Cavite	108030	Caluangan Elementary School	87
886	Region IV-A	Cavite	108031	Magallanes Elementary School	101
887	Region IV-A	Cavite	108032	Medina Elementary School	110
888	Region IV-A	Cavite	108033	Pacheco Elementary School	86
889	Region IV-A	Cavite	108034	Ramirez Elementary School	102
890	Region IV-A	Cavite	108035	Tua Elementary School	96
891	Region IV-A	Cavite	108036	Urdaneta Elementary School	86
892	Region IV-A	Cavite	108052	Anuling Elementary School	81
893	Region IV-A	Cavite	108053	Asis Elementary School	62
894	Region IV-A	Cavite	108054	Gahitan Elementary School	81
895	Region IV-A	Cavite	108055	Galicia Elementary School	64
896	Region IV-A	Cavite	108058	Panungyan Elementary School	75
897	Region IV-A	Cavite	108060	Bancaan Elementary School	84

No.	Region	Division	School ID	School Name	Sum of Total
898	Region IV-A	Cavite	108061	Bucana Elementary School	81
899	Region IV-A	Cavite	108064	Labac Elementary School	90
900	Region IV-A	Cavite	108086	Pacifico O. Aquino Elementary School	65
901	Region IV-A	Cavite	108102	Bulihan Sites & Services Project Elementary School	62
902	Region IV-A	Cavite	301166	Amadeo National High School	72
903	Region IV-A	Cavite	301167	Amaya School of Home Industries	60
904	Region IV-A	Cavite	301168	Anuling Integrated High School	91
905	Region IV-A	Cavite	301172	Bagbag National High School	69
906	Region IV-A	Cavite	301173	Bendita Integrated High School	175
907	Region IV-A	Cavite	301176	Caluangan National High School	80
908	Region IV-A	Cavite	301189	Emiliano T. Tirona Memorial National High School	82
909	Region IV-A	Cavite	301191	Gen. Emilio Aguinaldo-Bailen Integrated School	150
910	Region IV-A	Cavite	301193	Gen. Vito Belarmino Integrated National High School	119
911	Region IV-A	Cavite	301202	Lumil Integrated National High School	91
912	Region IV-A	Cavite	301205	Munting Ilog Integrated National High School	65
913	Region IV-A	Cavite	301207	Naic Integrated National High School	78
914	Region IV-A	Cavite	301208	Noveleta National High School	87
915	Region IV-A	Cavite	301211	Pulo ni Sara Integrated School	63
916	Region IV-A	Cavite	301212	Rosario National High School	70
917	Region IV-A	Cavite	301216	Tagaytay City National High School - Integrated Senior High School	80
918	Region IV-A	Cavite	301217	Talon Integrated School	70
919	Region IV-A	Cavite	301218	Tanza National Comprehensive High School	76
920	Region IV-A	Cavite	301219	Tanza National Trade School	96
921	Region IV-A	Cavite	301221	Ternate Integrated National High School	69
922	Region IV-A	Cavite	500924	Ulat Integrated School	84
923	Region IV-A	Cavite City	109634	Bagumbuhay ES	70
924	Region IV-A	Cavite City	301484	Cavite National High School	115
925	Region IV-A	Dasmariñas City	107909	Piela ES	70
926	Region IV-A	Dasmariñas City	107912	Salawag ES	63
927	Region IV-A	Dasmariñas City	107917	Dasmariñas II CS (Dasmariñas BBES B)	62
928	Region IV-A	Dasmariñas City	107922	San Miguel ES (Dasmariñas BBES A-3)	73
929	Region IV-A	Dasmariñas City	107923	Pintong Gubat Elementary School	61
930	Region IV-A	Dasmariñas City	301183	Dasmariñas East Integrated High School	70
931	Region IV-A	Dasmariñas City	301186	Dasmariñas Integrated High School	96
932	Region IV-A	Dasmariñas City	328201	Francisco E. Barzaga Integrated High School	74
933	Region IV-A	Imus City	107969	Anabu II Elementary School	68
934	Region IV-A	Imus City	107983	Carsadang Bago ES	96
935	Region IV-A	Laguna	108284	Famy Elementary School	61
936	Region IV-A	Laguna	108401	Pakil ES	69
937	Region IV-A	Laguna	108408	Linga ES	65
938	Region IV-A	Laguna	108447	Santisima Cruz ES	96
939	Region IV-A	Laguna	301228	Banca-Banca Integrated National High School	154
940	Region IV-A	Laguna	301243	Kabulusan Integrated National High School	85
941	Region IV-A	Laguna	301249	Mabitac NHS	75
942	Region IV-A	Laguna	301264	San Francisco Integrated NHS	72

No.	Region	Division	School ID	School Name	Sum of Total
943	Region IV-A	Laguna	301268	Sta. Catalina Integrated National High School	62
944	Region IV-A	Laguna	301273	Siniloan Integrated National High School	63
945	Region IV-A	Lucena City	308501	Lucena Dalahican National High School	65
946	Region IV-A	Lucena City	308503	Gulang-gulang National High School	78
947	Region IV-A	Quezon	108699	Angelo ES	73
948	Region IV-A	Quezon	108706	Dadyangaw ES	81
949	Region IV-A	Quezon	108716	Malining ES	88
950	Region IV-A	Quezon	108725	Umiray ES	75
951	Region IV-A	Quezon	108784	Cacawayan ES	70
952	Region IV-A	Quezon	108820	Sto. Niño ES	60
953	Region IV-A	Quezon	108830	Villaminda Elementary School	61
954	Region IV-A	Quezon	109039	Pagitan ES	92
955	Region IV-A	Quezon	109135	Tumbaga ES	62
956	Region IV-A	Quezon	109149	Rizal ES	60
957	Region IV-A	Quezon	301284	Alabat Island National High School	70
958	Region IV-A	Quezon	301305	Callejon NHS	60
959	Region IV-A	Quezon	301309	Casay National High School	113
960	Region IV-A	Quezon	301314	Cesar C. Tan Memorial National High School (formerly Cometa NHS Annex)	62
961	Region IV-A	Quezon	301323	Guinayangan NHS	67
962	Region IV-A	Quezon	301345	Lopez National Comprehensive High School	67
963	Region IV-A	Quezon	301365	JOEL B. ARQUIZA NHS	70
964	Region IV-A	Quezon	301367	Pagbilao Grande Island NHS	74
965	Region IV-A	Quezon	301374	Patnanungan NHS	78
966	Region IV-A	Quezon	301377	Polillo National High School	72
967	Region IV-A	Quezon	301386	San Francisco B NHS	83
968	Region IV-A	Quezon	301387	Ilayang Ilog-A NHS (Formerly San Francisco B NHS Ilayang Ilog A Ext.)	73
969	Region IV-A	Quezon	301389	Sto. Nino Ilaya NHS (Formerly San Francisco B NHS Sto. Niño Ilaya Ext.)	73
970	Region IV-A	Quezon	301404	Sto. Domingo NHS	63
971	Region IV-A	Quezon	301408	Taluong NHS	96
972	Region IV-A	Quezon	301409	Jacinto G. Esplana National High School	74
973	Region IV-A	Quezon	301412	Ungos Integrated NHS	65
974	Region IV-A	Quezon	308017	Apad NHS (Formerly Sto. Domingo NHS - Apad Ext. Classes)	108
975	Region IV-A	Quezon	308025	San Jose NHS (Formerly Tagbacan Ilaya Integ. Sec. Ext. Classes)	102
976	Region IV-A	Rizal	109385	Lunsad ES	95
977	Region IV-A	Rizal	109457	Virgilio B. Melendres Memorial Elementary School (Pililla ES Unit I)	118
978	Region IV-A	Rizal	109528	Felix M. Sanvictores ES	62
979	Region IV-A	Rizal	109532	Sitio Tapayan ES	106
980	Region IV-A	Rizal	109533	Sta. Ana Elementary School	77
981	Region IV-A	Rizal	301428	Bagumbong National High School	74
982	Region IV-A	Rizal	301435	Daraetan Integrated School	67
983	Region IV-A	Rizal	301447	Malaya National High School	70
984	Region IV-A	Rizal	301462	Silangan National High School	139
985	Region IV-A	Rizal	308121	Hulo National High School	60
986	Region IV-A	San Pedro City	108417	Adelina I Complex ES	60
987	Region IV-A	San Pedro City	108424	Langgam ES	60

No.	Region	Division	School ID	School Name	Sum of Total
988	Region IV-A	San Pedro City	108432	San Pedro CES	64
989	Region IV-A	San Pedro City	108433	San Roque Elementary School	78
990	Region IV-A	San Pedro City	108435	Sto. Niño ES	84
991	Region IV-A	San Pedro City	307907	San Pedro Relocation Center National High School, Main (Langgam) Campus	69
992	Region IV-A	Tanauan City	107754	Bilogbilog Elementary School	95
993	Region IV-A	Tanauan City	107756	Cale Elementary School	65
994	Region IV-A	Tanauan City	107768	Montana ES	64
995	Region IV-A	Tanauan City	107778	Sulpoc ES	64
996	Region IV-A	Tanauan City	301133	Pantay Integrated HS	84
997	Region IV-A	Tanauan City	301154	Tanauan School of Fisheries	90
998	Region IV-A	Tanauan City	321601	Tanauan City Integrated High School	85
999	Region IV-A	Tanauan City	321602	Balele Integrated High School	66
1000	Region IV-A	Tanauan City	500867	Ulango Integrated School	63
1001	Region IV-B	Calapan City	111560	Gutad Elementary School	83
1002	Region IV-B	Calapan City	111561	Caguisikan Elementary School	85
1003	Region IV-B	Calapan City	111567	Nag-iba Elementary School	73
1004	Region IV-B	Calapan City	301798	Canubing National High School	74
1005	Region IV-B	Calapan City	301800	Oriental Mindoro National High School	64
1006	Region IV-B	Calapan City	301801	Ceriacio A. Abes Memorial National High School	75
1007	Region IV-B	Calapan City	301802	Nag-iba National High School	121
1008	Region IV-B	Calapan City	301803	Pedro V. Panaligan Memorial National High School	77
1009	Region IV-B	Calapan City	301805	Managpi National High School	62
1010	Region IV-B	Calapan City	309402	Bucayao National High School	79
1011	Region IV-B	Marinduque	109893	Canat ES	65
1012	Region IV-B	Marinduque	308804	Paciano A. Sena Mem. HS (Tabionan NHS)	96
1013	Region IV-B	Occidental Mindoro	110080	Bulangcog ES	65
1014	Region IV-B	Occidental Mindoro	110191	Tuguilan Elementary School	94
1015	Region IV-B	Occidental Mindoro	110203	Pitogo Elementary School	118
1016	Region IV-B	Occidental Mindoro	110211	Claudio Salgado Elementary School	80
1017	Region IV-B	Occidental Mindoro	110212	El Dorado Elementary School	96
1018	Region IV-B	Occidental Mindoro	110258	Curanta ES	92
1019	Region IV-B	Occidental Mindoro	110264	Lagnas Elementary School	110
1020	Region IV-B	Occidental Mindoro	110269	San Agustin ES	102
1021	Region IV-B	Occidental Mindoro	137072	Ke-uring Elementary School	244
1022	Region IV-B	Occidental Mindoro	169505	Salafay Elementary School	79
1023	Region IV-B	Occidental Mindoro	301586	LUBANG VOCATIONAL HIGH SCHOOL	72
1024	Region IV-B	Occidental Mindoro	301594	Paluan NHS	75
1025	Region IV-B	Occidental Mindoro	301596	Sablayan National Comprehensive High School	64
1026	Region IV-B	Occidental Mindoro	301603	Santa Cruz NHS	60
1027	Region IV-B	Occidental Mindoro	301606	Tanyag NHS	90
1028	Region IV-B	Occidental Mindoro	500029	Lubang Integrated School	67
1029	Region IV-B	Oriental Mindoro	110319	Bayanan Elementary School	64
1030	Region IV-B	Oriental Mindoro	110326	Casillon Elementary School	93
1031	Region IV-B	Oriental Mindoro	110332	Julio R. Hernandez MS	69
1032	Region IV-B	Oriental Mindoro	110333	Katuwiran I ES	74

No.	Region	Division	School ID	School Name	Sum of Total
1033	Region IV-B	Oriental Mindoro	110415	Cabugao ES	71
1034	Region IV-B	Oriental Mindoro	110430	Upper Yunot ES	89
1035	Region IV-B	Oriental Mindoro	110462	Leonardo U. Tugade MS	124
1036	Region IV-B	Oriental Mindoro	110467	Felipe C. Anastacio ES	90
1037	Region IV-B	Oriental Mindoro	110509	Balite Mangyan School	94
1038	Region IV-B	Oriental Mindoro	110511	Caburo Mangyan School	75
1039	Region IV-B	Oriental Mindoro	110517	Mabini ES	125
1040	Region IV-B	Oriental Mindoro	110518	Leticia Medrano Cacha Elementary School	89
1041	Region IV-B	Oriental Mindoro	110522	Cornelio Lintawagin MES	87
1042	Region IV-B	Oriental Mindoro	110582	Sabang ES	315
1043	Region IV-B	Oriental Mindoro	110630	Dangay ES	85
1044	Region IV-B	Oriental Mindoro	110638	Paclasan ES	78
1045	Region IV-B	Oriental Mindoro	110646	San Vicente ES	106
1046	Region IV-B	Oriental Mindoro	110648	Tauga Diit ES	135
1047	Region IV-B	Oriental Mindoro	110664	Bagsok Elementary School	64
1048	Region IV-B	Oriental Mindoro	170027	Lapantay Mangyan School	61
1049	Region IV-B	Oriental Mindoro	170030	Sido Mangyan School	86
1050	Region IV-B	Oriental Mindoro	301630	Doroteo S. Mendoza Sr. MNHS	95
1051	Region IV-B	Oriental Mindoro	301640	Dangay NHS	170
1052	Region IV-B	Oriental Mindoro	309009	Jose D. Udasco Mangangan I NHS	68
1053	Region IV-B	Oriental Mindoro	309021	San Vicente National High School	72
1054	Region IV-B	Oriental Mindoro	309024	Bonbon High School	108
1055	Region IV-B	Palawan	110884	Mate Elementary School	213
1056	Region IV-B	Palawan	111023	El Nido Central School	62
1057	Region IV-B	Palawan	111061	Cacarigan Elementary School	96
1058	Region IV-B	Palawan	111206	Alacalian Elementary School	69
1059	Region IV-B	Palawan	111214	Bulalo Elementary School	64
1060	Region IV-B	Palawan	170586	Nanabu Indigenous People Elementary School	143
1061	Region IV-B	Palawan	301677	Cagayancillo National High School	95
1062	Region IV-B	Palawan	301680	Candawaga National High School	97
1063	Region IV-B	Palawan	301687	Culion Sanitarium Special National High School	78
1064	Region IV-B	Palawan	301711	New Busuanga National High School	121
1065	Region IV-B	Palawan	301720	Panlaitan National High School	84
1066	Region IV-B	Palawan	309126	Tarusan National High School	75
1067	Region IV-B	Puerto Princesa City	111485	Mateo Jagmis MES	64
1068	Region IV-B	Puerto Princesa City	111519	Makandring ES	66
1069	Region IV-B	Puerto Princesa City	111524	Marufinas ES	105
1070	Region IV-B	Puerto Princesa City	301782	Inagawan NHS	85
1071	Region IV-B	Puerto Princesa City	301793	San Jose NHS	71
1072	Region IV-B	Romblon	111286	Dulangan ES	128
1073	Region IV-B	Romblon	301771	San Andres NHS	126
1074	Region IX	Isabela City	126035	Old Camp Elementary School	106
1075	Region IX	Isabela City	303894	Basilan NHS	126
1076	Region IX	Pagadian City	303911	San Pedro National High School	64
1077	Region IX	Zamboanga City	126209	Rio Hondo ES	83

No.	Region	Division	School ID	School Name	Sum of Total
1078	Region IX	Zamboanga City	126231	Tugbungan ES	69
1079	Region IX	Zamboanga del Norte	124314	Mamawan ES	137
1080	Region IX	Zamboanga del Norte	124323	Bitoon ES	69
1081	Region IX	Zamboanga del Norte	124345	Concepcion ES	66
1082	Region IX	Zamboanga del Norte	124357	San Jose ES	79
1083	Region IX	Zamboanga del Norte	124492	Balubo ES	166
1084	Region IX	Zamboanga del Norte	124493	Balubohan ES	127
1085	Region IX	Zamboanga del Norte	124504	Panampalay Elementary School	81
1086	Region IX	Zamboanga del Norte	124528	Lupasang Elementary School	74
1087	Region IX	Zamboanga del Norte	124571	Crisologo ES	77
1088	Region IX	Zamboanga del Norte	124608	New Dapitan ES	62
1089	Region IX	Zamboanga del Norte	124658	Kauswagan ES	68
1090	Region IX	Zamboanga del Norte	124665	Nueva Vista ES	69
1091	Region IX	Zamboanga del Norte	124666	Pedagan ES	94
1092	Region IX	Zamboanga del Norte	124700	Seriac ES	63
1093	Region IX	Zamboanga del Norte	124715	Guimba Parang ES	82
1094	Region IX	Zamboanga del Norte	124722	Lipuno ES	73
1095	Region IX	Zamboanga del Norte	124726	Malayal Community School	63
1096	Region IX	Zamboanga del Norte	124789	Bucana ES	67
1097	Region IX	Zamboanga del Norte	195513	Dipodog ES	77
1098	Region IX	Zamboanga del Norte	195531	Sulot Sumayong ES	63
1099	Region IX	Zamboanga del Norte	303683	Dumalogdog National High School	321
1100	Region IX	Zamboanga del Norte	303689	Julian Soriano Memorial Comprehensive High School	102
1101	Region IX	Zamboanga del Norte	303692	Pianon National High School	64
1102	Region IX	Zamboanga del Norte	303710	Manukan National High School	143
1103	Region IX	Zamboanga del Norte	303723	San Isidro NHS	131
1104	Region IX	Zamboanga del Norte	303731	Diongan National High School	157
1105	Region IX	Zamboanga del Norte	314118	Saluyong NHS	124
1106	Region IX	Zamboanga del Sur	124968	Legarda Tres ES	67
1107	Region IX	Zamboanga del Sur	125047	Lipawan ES	65
1108	Region IX	Zamboanga del Sur	125054	Saad ES	169
1109	Region IX	Zamboanga del Sur	125100	Kumalarang CES	96
1110	Region IX	Zamboanga del Sur	125116	Dipaya Elementary School	73
1111	Region IX	Zamboanga del Sur	125141	Gasa Elementary School	73
1112	Region IX	Zamboanga del Sur	125237	Dakayakan IES	76
1113	Region IX	Zamboanga del Sur	125464	Tigbao CES	63
1114	Region IX	Zamboanga del Sur	303822	Toribio Minor NHS	523
1115	Region IX	Zamboanga del Sur	314244	PARAISO NATIONAL HIGH SCHOOL (FORMERLY PANAGAAN NHS - PARAISO EXTENSION)	71
1116	Region IX	Zamboanga Sibugay	125580	Paradise Elementary School	122
1117	Region IX	Zamboanga Sibugay	125624	Maasin Elementary School	62
1118	Region IX	Zamboanga Sibugay	125633	Tomitom Elementary School	62
1119	Region IX	Zamboanga Sibugay	125651	Peñaranda Elementary School	88
1120	Region IX	Zamboanga Sibugay	125678	Sawa Elementary School	113
1121	Region IX	Zamboanga Sibugay	125714	Capt. Pedro Changco Sr. Elementary School	62
1122	Region IX	Zamboanga Sibugay	125731	Upper Tipan Elementary School	127

No.	Region	Division	School ID	School Name	Sum of Total
1123	Region IX	Zamboanga Sibugay	125739	Kalines Elementary School	67
1124	Region IX	Zamboanga Sibugay	125813	Balingasan Elementary School	93
1125	Region IX	Zamboanga Sibugay	125838	Sibuguey Elementary School	78
1126	Region IX	Zamboanga Sibugay	196523	Goling Elementary School	103
1127	Region IX	Zamboanga Sibugay	303824	Alicia National High School	67
1128	Region IX	Zamboanga Sibugay	303829	Buug National High School	92
1129	Region IX	Zamboanga Sibugay	303849	Naga National High School	153
1130	Region IX	Zamboanga Sibugay	303851	Olutanga National High School	104
1131	Region IX	Zamboanga Sibugay	303873	Malagandis National High School	70
1132	Region IX	Zamboanga Sibugay	303874	Tungawan National High School	249
1133	Region IX	Zamboanga Sibugay	314325	Dionisio Lopez Sr. National High School	120
1134	Region V	Albay	111637	Quirangay Elementary School	70
1135	Region V	Albay	111649	Panoypoy Elementary School	61
1136	Region V	Albay	111651	TAGAYTAY ELEMENTARY SCHOOL	83
1137	Region V	Albay	111665	Busay Elementary School	61
1138	Region V	Albay	111667	Daraga North Central School	70
1139	Region V	Albay	111710	Guinobatan East Central School	71
1140	Region V	Albay	111712	Maipon Elementary School	95
1141	Region V	Albay	111727	Guinobatan West Central School	61
1142	Region V	Albay	111759	Bacolod Elementary School	71
1143	Region V	Albay	111762	Libon East Central School	63
1144	Region V	Albay	111798	Pantao Elementary School	98
1145	Region V	Albay	111870	Baybay Elementary School	62
1146	Region V	Albay	111908	Bogtong Elementary School	82
1147	Region V	Albay	111921	San Antonio Elementary School	73
1148	Region V	Albay	111923	Tablon Elementary School	83
1149	Region V	Albay	111925	Tapel Elementary School	71
1150	Region V	Albay	112010	Matacon Elementary School	106
1151	Region V	Albay	112011	Polangui South Central School	100
1152	Region V	Albay	112030	Guinanayan Elementary School	61
1153	Region V	Albay	112034	Malobago Elementary School	72
1154	Region V	Albay	112051	Bagong San Roque Elementary School	70
1155	Region V	Albay	172503	San Jose Elementary School	74
1156	Region V	Albay	301812	Bariw National High School	129
1157	Region V	Albay	301813	Batan National High School	61
1158	Region V	Albay	301833	Libon Agro-Industrial High School	70
1159	Region V	Albay	301835	Buga National High School	138
1160	Region V	Albay	301847	Nagotgot High School	61
1161	Region V	Albay	301849	Marcial O. Rañola Memorial School	141
1162	Region V	Albay	301851	Masarawag National High School	89
1163	Region V	Albay	301865	Polangui General Comprehensive High School	142
1164	Region V	Albay	301871	San Antonio National High School	87
1165	Region V	Albay	301873	San Isidro National High School	119
1166	Region V	Albay	301877	San Vicente National High School	63
1167	Region V	Albay	301879	Sto. Domingo National High School	107

No.	Region	Division	School ID	School Name	Sum of Total
1168	Region V	Albay	301883	Bogtong National High School	81
1169	Region V	Albay	301885	Vinisitahan National High School	79
1170	Region V	Albay	309502	San Pablo High School	78
1171	Region V	Albay	309504	Rawis High School	73
1172	Region V	Albay	309510	Mamlad High School	72
1173	Region V	Albay	309512	San Miguel High School	112
1174	Region V	Albay	309516	Malidong High School	93
1175	Region V	Albay	309520	Malabiga High School	79
1176	Region V	Albay	500155	San Agustin Integrated School	96
1177	Region V	Camarines Norte	112168	San Martin Elementary School	66
1178	Region V	Camarines Norte	112228	Lalawigan Elementary School	86
1179	Region V	Camarines Norte	112246	Dalnac Elementary School	64
1180	Region V	Camarines Norte	112250	Macolabo Elementary School	102
1181	Region V	Camarines Norte	112302	Don Miguel Lukban Elementary School	103
1182	Region V	Camarines Norte	112310	Matango Elementary School	70
1183	Region V	Camarines Norte	173005	Guitol Elementary School	60
1184	Region V	Camarines Norte	301900	Lalawigan National High School	138
1185	Region V	Camarines Norte	301904	Matango National High School	63
1186	Region V	Camarines Norte	301911	Gumaus National High School	76
1187	Region V	Camarines Norte	301914	Sabang National High School, Vinzons	95
1188	Region V	Camarines Norte	309603	Caringo High School	77
1189	Region V	Camarines Sur	112365	Bato South Central School	60
1190	Region V	Camarines Sur	112374	Mangga Elementary School	80
1191	Region V	Camarines Sur	112460	Castillo ES	102
1192	Region V	Camarines Sur	112466	Balongay ES	68
1193	Region V	Camarines Sur	112502	Sua Elementary School	158
1194	Region V	Camarines Sur	112556	Oring ES	76
1195	Region V	Camarines Sur	112589	Ason ES	65
1196	Region V	Camarines Sur	112590	Bahi ES	84
1197	Region V	Camarines Sur	112641	Himanag Elementary School	61
1198	Region V	Camarines Sur	112647	Pagsimbugan Elementary School	62
1199	Region V	Camarines Sur	112684	Malbogon Elementary School	60
1200	Region V	Camarines Sur	112814	Baras ES	78
1201	Region V	Camarines Sur	112849	Cagmanaba ES	79
1202	Region V	Camarines Sur	112909	Macad ES	63
1203	Region V	Camarines Sur	112964	Panaytayan ES	80
1204	Region V	Camarines Sur	112993	Turague ES	118
1205	Region V	Camarines Sur	113099	Gaao ES	65
1206	Region V	Camarines Sur	173543	Caloocan Elementary School	84
1207	Region V	Camarines Sur	301928	Antipolo National High School, Tinambac	65
1208	Region V	Camarines Sur	301944	Binagasbasan National High School	91
1209	Region V	Camarines Sur	301966	Del Gallego National High School	66
1210	Region V	Camarines Sur	301972	Siruma High School (Fundado High School Annex)	91
1211	Region V	Camarines Sur	301973	Gainza National High School	74
1212	Region V	Camarines Sur	301992	Tandaay Provincial High School	74

No.	Region	Division	School ID	School Name	Sum of Total
1213	Region V	Camarines Sur	301996	Mansalaya National High School	65
1214	Region V	Camarines Sur	302008	Oring National High School	66
1215	Region V	Camarines Sur	302013	PAMUKID NATIONAL HIGH SCHOOL	69
1216	Region V	Camarines Sur	302025	Sagrada Familia High School	61
1217	Region V	Camarines Sur	302054	Tabgon High School	63
1218	Region V	Camarines Sur	309725	Laganac High School	70
1219	Region V	Catanduanes	113154	Bugao CES	92
1220	Region V	Catanduanes	113190	San Roque ES	70
1221	Region V	Catanduanes	113246	Bayhan PS	93
1222	Region V	Catanduanes	113252	Panay Comm. Sch.	112
1223	Region V	Catanduanes	113281	San Isidro ES	79
1224	Region V	Catanduanes	113309	Botinagan ES	63
1225	Region V	Catanduanes	113339	Dugui San Isidro Elementary School	195
1226	Region V	Catanduanes	113340	Dugui Too Elementary School	117
1227	Region V	Catanduanes	113341	Dugui Wala ES	179
1228	Region V	Catanduanes	302072	Bagamanoc Rural DHS	64
1229	Region V	Catanduanes	302083	Catanduanes NHS	66
1230	Region V	Catanduanes	500159	Cobo Integrated School	62
1231	Region V	Legaspi City	114477	Cabagnan ES	62
1232	Region V	Legaspi City	114478	Dapdap ES	97
1233	Region V	Legaspi City	114493	Rawis ES	81
1234	Region V	Legaspi City	302257	Banquerohan National High School	76
1235	Region V	Legaspi City	302258	Oro Site High School	63
1236	Region V	Legaspi City	302260	Cabangan High School	85
1237	Region V	Legaspi City	302262	Gogon High School	73
1238	Region V	Legaspi City	310201	Arimbay High School	66
1239	Region V	Legaspi City	310202	Legazpi City Science High School	67
1240	Region V	Ligao City	111848	Cristina R. Princesa Mem. ES	65
1241	Region V	Ligao City	111851	Tinampo ES	74
1242	Region V	Ligao City	301820	Deogracias P. Princesa Memorial High School	122
1243	Region V	Ligao City	301838	Bacong High School	64
1244	Region V	Masbate	113419	Baao Elementary School	119
1245	Region V	Masbate	113457	Mapili ES	88
1246	Region V	Masbate	113583	Malacbalac ES	80
1247	Region V	Masbate	113601	Cabrera ES	70
1248	Region V	Masbate	113735	Baang ES	63
1249	Region V	Masbate	113744	Lomocloc ES	67
1250	Region V	Masbate	113769	Maglambong Elementary School	62
1251	Region V	Masbate	113771	Morocborocan Elementary School	69
1252	Region V	Masbate	302118	G. Bangalisan National High School	83
1253	Region V	Masbate	302126	Tito R. Espinosa Memorial National Agricultural School	101
1254	Region V	Masbate	302127	Buyo National High School	63
1255	Region V	Masbate	302129	Cataingan National High School	164
1256	Region V	Masbate	302135	Felixberto Del Rosario, Jr. Memorial High School	79
1257	Region V	Masbate	302145	Federico A. Estipona Memorial High School	108

No.	Region	Division	School ID	School Name	Sum of Total
1258	Region V	Masbate	302161	Liberato P. Tacurda Sr. HS	76
1259	Region V	Masbate	302166	San Isidro National High School	76
1260	Region V	Masbate	302172	Tanque National High School	97
1261	Region V	Masbate	309904	Palanas National Agriculture High School	68
1262	Region V	Masbate	309935	Mababangbaybay National High School	79
1263	Region V	Masbate	500161	Iniwaran Integrated School	83
1264	Region V	Masbate City	321802	Usab High School	71
1265	Region V	Masbate City	321805	Bantigue High School	62
1266	Region V	Masbate City	500393	Alejandro Delos Reyes Integrated School	73
1267	Region V	Naga City	114508	Julian B. Meliton Elementary School	70
1268	Region V	Naga City	114511	Tinago Central School	74
1269	Region V	Naga City	114514	Jose Rizal Elementary School	147
1270	Region V	Naga City	114518	Tabuco Central School	74
1271	Region V	Naga City	176501	Morada-Ramos Elementary School	63
1272	Region V	Sorsogon	114086	Gogon ES	69
1273	Region V	Sorsogon	114158	Bandi ES	143
1274	Region V	Sorsogon	114281	Magallanes North CS	68
1275	Region V	Sorsogon	114320	Manjumlad ES	61
1276	Region V	Sorsogon	114325	Pawa ES	92
1277	Region V	Sorsogon	114337	Bantayan ES	263
1278	Region V	Sorsogon	114339	Binanuahan ES	154
1279	Region V	Sorsogon	114369	Catamlangan ES	75
1280	Region V	Sorsogon	302181	Olimpio A. Guarin Jr. National High School	90
1281	Region V	Sorsogon	302186	Biriran National High School	88
1282	Region V	Sorsogon	302188	Buhang National High School	99
1283	Region V	Sorsogon	302203	Danao National High Sschool	330
1284	Region V	Sorsogon	302212	Gallanosa National High School	103
1285	Region V	Sorsogon	302220	Magallanes National Vocational High School	65
1286	Region V	Sorsogon	302222	Magallanes National High School	69
1287	Region V	Sorsogon	302225	Matnog National High School	151
1288	Region V	Sorsogon	302227	Milagrosa National High School	73
1289	Region V	Sorsogon	302233	Quezon National High School	71
1290	Region V	Sorsogon	302235	Jupi National High School	68
1291	Region V	Sorsogon	302243	Siuton National High School	67
1292	Region V	Sorsogon	302245	Sta. Magdalena National High School	110
1293	Region V	Sorsogon	310003	Guruyan High School	76
1294	Region V	Sorsogon City	114563	Sorsogon East Central School	66
1295	Region V	Tabaco City	114587	Mayon ES	62
1296	Region V	Tabaco City	302285	Tabaco National High School	70
1297	Region VI	Aklan	114694	Man-up ES	83
1298	Region VI	Aklan	114716	Aquino ES	118
1299	Region VI	Aklan	114775	Bonza PS	65
1300	Region VI	Aklan	114800	Taroytoy Elementary School (Tarotoy PS)	68
1301	Region VI	Aklan	114845	Argao Elem. School	76
1302	Region VI	Aklan	114846	Balabag ES	125

No.	Region	Division	School ID	School Name	Sum of Total
1303	Region VI	Aklan	114876	Tambuan Elementary School	76
1304	Region VI	Aklan	178004	Angeles Ibardolasa Elementary School	64
1305	Region VI	Aklan	302295	Boracay NHS-Main	90
1306	Region VI	Aklan	302305	Anselmo B. Legaspi NHS	64
1307	Region VI	Aklan	302306	Daja Sur National High School	65
1308	Region VI	Aklan	302315	Madalag NHS	69
1309	Region VI	Aklan	302324	Aklan NHS for Arts & Trades	109
1310	Region VI	Aklan	500174	Ortega Integrated School	212
1311	Region VI	Aklan	500181	Dalagsaan Integrated School	107
1312	Region VI	Aklan	500638	Agtughangin IS	66
1313	Region VI	Antique	114995	Pangalcagan ES	63
1314	Region VI	Antique	115001	Yapu ES	70
1315	Region VI	Antique	115074	La Paz ES	83
1316	Region VI	Antique	115093	Mapatag ES	79
1317	Region VI	Antique	115143	Badiangan ES	82
1318	Region VI	Antique	115175	Apgahan ES	70
1319	Region VI	Antique	115187	Tamayoc ES	76
1320	Region VI	Antique	115190	Villa Flores Elementary School	79
1321	Region VI	Antique	115216	Banusing-Serdeña Elementary School	88
1322	Region VI	Antique	115219	Durog ES	80
1323	Region VI	Antique	115239	Carawisan ES	81
1324	Region VI	Antique	115258	BUGO CENTRAL SCHOOL	73
1325	Region VI	Antique	115261	General Fullon ES	67
1326	Region VI	Antique	115344	Malabor ES	65
1327	Region VI	Antique	115346	Nonghinong Elementary School	86
1328	Region VI	Antique	115347	Pitac ES	65
1329	Region VI	Antique	115391	Borocboroc ES	92
1330	Region VI	Antique	178501	Anilawan PS	67
1331	Region VI	Antique	178516	Mayabay Elementary School	149
1332	Region VI	Antique	302353	Diclum National High School	75
1333	Region VI	Antique	302356	Governor Julian Fullon Pacificador National School	66
1334	Region VI	Antique	302357	Gideon M. Cabigunda MS	64
1335	Region VI	Antique	302362	Laua-an NHS	182
1336	Region VI	Antique	302364	Lirio M. Escaño NHS	73
1337	Region VI	Antique	302375	San Pedro NHS	62
1338	Region VI	Antique	302383	Union NHS	85
1339	Region VI	Antique	310705	Semirara NHS	65
1340	Region VI	Antique	310707	Gov. Evelio B. Javier MNHS	108
1341	Region VI	Bacolod City	117450	Andres Bonifacio Elementary School II	67
1342	Region VI	Bacolod City	302700	Alangilan National High School	64
1343	Region VI	Bacolod City	302701	Bacolod City National High School	71
1344	Region VI	Bacolod City	302702	Barangay Singcang Airport National High School	74
1345	Region VI	Bacolod City	302705	Domingo Lacson National High School	79
1346	Region VI	Bacolod City	302716	Sum-ag National High School	94
1347	Region VI	Bacolod City	500189	M.G. Medalla Integrated School	84

No.	Region	Division	School ID	School Name	Sum of Total
1348	Region VI	Bacolod City	500190	Fr. Gratian Murray, AFSC Integrated School	75
1349	Region VI	Bago City	117499	Ma. Rosario Araneta ES	85
1350	Region VI	Bago City	302724	Ramon Torres Louisiana NHS	64
1351	Region VI	Cadiz City	302733	Tiglawigan NHS	99
1352	Region VI	Cadiz City	311405	Banquerohan National High School	77
1353	Region VI	Capiz	115414	Bito-on Elementary School	77
1354	Region VI	Capiz	115417	Carataya ES (cuartero)	74
1355	Region VI	Capiz	115419	Lunayan E/S	118
1356	Region VI	Capiz	115532	Jamindan ES	69
1357	Region VI	Capiz	115558	Carmen Alovera Amistoso ES	61
1358	Region VI	Capiz	115580	Balat-an Elementary School	75
1359	Region VI	Capiz	115594	Pangpang Norte Elementary School	83
1360	Region VI	Capiz	115604	Mambusao ES	69
1361	Region VI	Capiz	115611	Agbalo ES	150
1362	Region VI	Capiz	115666	Blasco PS	62
1363	Region VI	Capiz	115743	Maninang ES	80
1364	Region VI	Capiz	115745	Sapian Elementary School	80
1365	Region VI	Capiz	115746	WENCESLAO ONAS ELEM. SCHOOL	86
1366	Region VI	Capiz	115750	Balogo Primary School	64
1367	Region VI	Capiz	115753	DAYHAGON ELEMENTARY SCHOOL	63
1368	Region VI	Capiz	115762	Matinabus ES	69
1369	Region VI	Capiz	115766	Sigma CES	99
1370	Region VI	Capiz	115803	Agpalali ES	89
1371	Region VI	Capiz	115818	Tabon Elementary School	102
1372	Region VI	Capiz	302396	Cuartero NHS	61
1373	Region VI	Capiz	302399	Vicente Andaya Sr. NHS	72
1374	Region VI	Capiz	302407	Macario Delfin Bermejo NHS	61
1375	Region VI	Capiz	302422	San Nicolas NHS (Pilar)	80
1376	Region VI	Capiz	310809	REV. TOMAS CONEJAR NHS (katipunan)	107
1377	Region VI	Capiz	500428	Agkawayan Integrated School	80
1378	Region VI	Capiz	501095	Calixto Loyola Sr. Integrated School	76
1379	Region VI	Guimaras	115862	Don Pedro Vasquez Memorial School	66
1380	Region VI	Guimaras	115864	Jordan Central School	65
1381	Region VI	Himamaylan City	302610	Carabalan NHS	62
1382	Region VI	Iloilo	115919	Alejo Posadas MES	73
1383	Region VI	Iloilo	116261	Salvacion ES	75
1384	Region VI	Iloilo	116388	Atimonan Elementary School	78
1385	Region VI	Iloilo	116391	Canauillan ES	94
1386	Region VI	Iloilo	116397	Leon Consumo MES	78
1387	Region VI	Iloilo	116446	Bonbon Elementary School	61
1388	Region VI	Iloilo	116464	Panuran ES	83
1389	Region VI	Iloilo	116477	Leganes CES	78
1390	Region VI	Iloilo	116481	Alcantara PS	71
1391	Region VI	Iloilo	116482	Almifana ES	66
1392	Region VI	Iloilo	116483	Bantegui ES	102

No.	Region	Division	School ID	School Name	Sum of Total
1393	Region VI	Iloilo	116488	Concepcion Juanillo MES	75
1394	Region VI	Iloilo	116489	Cristito Lapating MES	82
1395	Region VI	Iloilo	116492	Jose Almiñana MES	76
1396	Region VI	Iloilo	116581	Dalije ES	68
1397	Region VI	Iloilo	116620	Botong-Cabanbanan Elem. School	73
1398	Region VI	Iloilo	116623	Cambitu Elemenratry School	67
1399	Region VI	Iloilo	116683	Hda. Conchita ES	63
1400	Region VI	Iloilo	116686	Manduawak ES	81
1401	Region VI	Iloilo	116687	Manuel D. Doriquez Sr. ES	336
1402	Region VI	Iloilo	116847	Isauan-Talento Elementary School	67
1403	Region VI	Iloilo	180012	Pontoc Elementary School	71
1404	Region VI	Iloilo	180039	Dao PS	66
1405	Region VI	Iloilo	302444	Alcarde Gustilo Mem. National High School	68
1406	Region VI	Iloilo	302445	Alejandro Firmeza MNHS	103
1407	Region VI	Iloilo	302467	Botong-Cabanbanan NHS	64
1408	Region VI	Iloilo	302473	Cabatuan NCHS	85
1409	Region VI	Iloilo	302478	Calmay NHS	86
1410	Region VI	Iloilo	302486	Culasi NHS	106
1411	Region VI	Iloilo	302490	Dingle NHS	95
1412	Region VI	Iloilo	302500	Estancia National High School	65
1413	Region VI	Iloilo	302503	Gines National High School	114
1414	Region VI	Iloilo	302509	Iloilo NHS	92
1415	Region VI	Iloilo	302523	Luca NHS	83
1416	Region VI	Iloilo	302531	Miagao NHS	160
1417	Region VI	Iloilo	302545	Bacolod NHS	63
1418	Region VI	Iloilo	302547	Panuran NHS	75
1419	Region VI	Iloilo	302554	Pitogo National High School	66
1420	Region VI	Iloilo	302555	Polopiña NHS	87
1421	Region VI	Iloilo	302560	Roberto and Gloria Lorca Tirol NHS	176
1422	Region VI	Iloilo	302561	Salihid NHS	66
1423	Region VI	Iloilo	302570	Sara NHS	70
1424	Region VI	Iloilo	311011	Adriano Cabardo NHS	94
1425	Region VI	Iloilo	311021	Tacuyong Sur NHS	63
1426	Region VI	Iloilo	311023	Bad-as NHS	193
1427	Region VI	Iloilo	311027	SINAMAY NATIONAL HIGH SCHOOL	85
1428	Region VI	Iloilo	311028	Dalid National High School	1,272
1429	Region VI	Iloilo	501244	Barasalon Integrated School	132
1430	Region VI	Iloilo City	117582	E. Yusay MS	94
1431	Region VI	Iloilo City	117597	Jaro ES I	62
1432	Region VI	Iloilo City	117605	Graciano Lopez Jaena ES	75
1433	Region VI	Iloilo City	302749	Mandurriao NHS	100
1434	Region VI	Kabankalan City	302787	Carol-an National High School	67
1435	Region VI	Negros Occidental	116938	Tinibiangan Elementary School	65
1436	Region VI	Negros Occidental	116956	PAALAALANG PAARALAN NG ALEJANDRO OMBI-ON	72
1437	Region VI	Negros Occidental	116970	M. Ledesma ES	61

No.	Region	Division	School ID	School Name	Sum of Total
1438	Region VI	Negros Occidental	116986	Tiling ES	69
1439	Region VI	Negros Occidental	116987	Tomina ES	62
1440	Region VI	Negros Occidental	117146	Cemeco ES	63
1441	Region VI	Negros Occidental	117156	Payab-on ES	67
1442	Region VI	Negros Occidental	117231	Camandag ES	73
1443	Region VI	Negros Occidental	117307	Trinidad ES	68
1444	Region VI	Negros Occidental	117327	Bagong Silang ES	65
1445	Region VI	Negros Occidental	117424	Batuan ES	103
1446	Region VI	Negros Occidental	302599	Bulwangan NHS	91
1447	Region VI	Negros Occidental	302612	CAUAYAN NATIONAL HIGH SCHOOL	63
1448	Region VI	Negros Occidental	302669	Negros Occidental HS	63
1449	Region VI	Negros Occidental	302686	Tabao NHS	71
1450	Region VI	Roxas City	117670	Mongpong ES	69
1451	Region VI	Roxas City	302755	Bago National High School	105
1452	Region VI	Roxas City	500193	Marcos Fuentes IS	92
1453	Region VI	Sagay City	117727	Melchor D. Salcedo Elementary School	66
1454	Region VI	Sagay City	302763	Campo Bago National High School	69
1455	Region VI	San Carlos City	117759	Gigalaman ES	115
1456	Region VI	San Carlos City	117766	Tal-ot ES	99
1457	Region VI	Silay City	117814	Eustaquio Lopez Elementary School	65
1458	Region VI	Sipalay City	302664	Nabulao NHS	79
1459	Region VII	Bais City	120084	Biso Elementary School	75
1460	Region VII	Bais City	323007	Mansangaban National High School	91
1461	Region VII	Bayawan City	120131	Kasla Elementary School	69
1462	Region VII	Bayawan City	303217	Basay National High School	112
1463	Region VII	Bogo City	302931	Binabag NHS	136
1464	Region VII	Bogo City	302933	Don Potenciano Catarata MNHS	104
1465	Region VII	Bohol	118027	Bien Unido Central ES	71
1466	Region VII	Bohol	118774	Bilang-Bilangan ES	63
1467	Region VII	Bohol	302861	Francisco L. Adlaon HS	71
1468	Region VII	Bohol	302877	Mantacida National High School	126
1469	Region VII	Bohol	302885	Policronio S. Dano, Sr. HS	90
1470	Region VII	Bohol	312325	Juanito-Paula Cruse High School	90
1471	Region VII	Cebu	118947	Colawin ES	88
1472	Region VII	Cebu	118964	Agbanga ES	77
1473	Region VII	Cebu	118989	Sta. Rita ES	67
1474	Region VII	Cebu	118990	Tag-amakan ES	104
1475	Region VII	Cebu	119021	Cabagdalan ES	62
1476	Region VII	Cebu	119047	Sunog Elementary School	63
1477	Region VII	Cebu	119213	Cambangkaya ES	73
1478	Region VII	Cebu	119243	Lanipga ES	588
1479	Region VII	Cebu	119394	Pawa ES	65
1480	Region VII	Cebu	119817	Matnog ES	102
1481	Region VII	Cebu	119827	Bakyawan ES	63
1482	Region VII	Cebu	119834	Gimama-a ES	70

No.	Region	Division	School ID	School Name	Sum of Total
1483	Region VII	Cebu	119848	Marmol ES	76
1484	Region VII	Cebu	302966	Calumboyan NHS	151
1485	Region VII	Cebu	302974	Cabalawan NHS	91
1486	Region VII	Cebu	303096	Madridejos NHS (Alegria)	78
1487	Region VII	Cebu	303109	Liki NHS	81
1488	Region VII	Cebu	303116	Tubod National High School	95
1489	Region VII	Cebu	303122	Lorenzo C. Tanza Memorial National High School	85
1490	Region VII	Cebu	312423	Mar and Dorie Darunday NHS	64
1491	Region VII	Cebu	312430	Salag NHS	66
1492	Region VII	Cebu	500219	Argawanon Integrated School	75
1493	Region VII	Cebu	500220	Anapog IS	74
1494	Region VII	Cebu	500667	Marikaban Integrated School	81
1495	Region VII	Cebu	501269	Pablo B. Villamera Integrated School	70
1496	Region VII	Cebu City	312509	Bitlang National High School	80
1497	Region VII	Cebu City	500224	Dr. Emilio Osmeña ES	80
1498	Region VII	Cebu City	500225	Tabunan Integrated School	113
1499	Region VII	Guihulngan City	120235	Binobohan ES	73
1500	Region VII	Guihulngan City	120256	Paz Salvador Laguda MES	61
1501	Region VII	Guihulngan City	120259	Jacinto Baquilta ES	62
1502	Region VII	Guihulngan City	303230	GUIHULNGAN NATIONAL AGRICULTURAL SCHOOL	120
1503	Region VII	Guihulngan City	312952	Linantuyan National High School	84
1504	Region VII	Mandaue City	303199	Mandaue City Comprehensive NHS	74
1505	Region VII	Mandaue City	303204	Tipolo NHS	62
1506	Region VII	Negros Oriental	120027	Panusuan Elementary School	76
1507	Region VII	Negros Oriental	120171	Bindoy Central Elementary School	61
1508	Region VII	Negros Oriental	120195	Tinaogan ES	72
1509	Region VII	Negros Oriental	120200	Bucalan Elementary School	64
1510	Region VII	Negros Oriental	120352	Cansal-ing Elementary School	61
1511	Region VII	Negros Oriental	120353	Cantombol Elementary School	67
1512	Region VII	Negros Oriental	120363	Lapong Elementary School	61
1513	Region VII	Negros Oriental	120379	Tingtingon ES	70
1514	Region VII	Negros Oriental	120454	Casalaan ES	167
1515	Region VII	Negros Oriental	120496	Sibulan Central Elementary School	79
1516	Region VII	Negros Oriental	120507	Cawitan Elementary School	82
1517	Region VII	Negros Oriental	120508	Danao Elementary School	83
1518	Region VII	Negros Oriental	120524	Talalak Elementary School	63
1519	Region VII	Negros Oriental	120527	Bago-Bago ES	94
1520	Region VII	Negros Oriental	120530	Canioogan Valley Elementary School	67
1521	Region VII	Negros Oriental	120597	Sacsac ES	98
1522	Region VII	Negros Oriental	120620	Puhagan Elementary School	127
1523	Region VII	Negros Oriental	189508	Jagna ES	71
1524	Region VII	Negros Oriental	189515	Tamao Elementary School	64
1525	Region VII	Negros Oriental	189523	Lanot Elementary School	62
1526	Region VII	Negros Oriental	303207	Amlan National High School	80
1527	Region VII	Tanjay City	120550	Doña Loreto Ledesma Mapa (Nagsala ES)	61

No.	Region	Division	School ID	School Name	Sum of Total
1528	Region VII	Tanjay City	120551	Doña Salome L. Villegas Memorial School	62
1529	Region VII	Tanjay City	120571	Obogon Elementary School	69
1530	Region VII	Tanjay City	303288	Lourdes L. del Prado MNHS (Sto. Niño)	64
1531	Region VII	Toledo City	303311	General Climaco NHS	92
1532	Region VII	Toledo City	303318	LURAY II NATIONAL HIGH SCHOOL (DAY & NIGHT))	85
1533	Region VIII	Biliran	120774	Biliran Central School	72
1534	Region VIII	Borongan City	303511	Lalawigan National High School	68
1535	Region VIII	Calbayog City	313802	Migara National High School	108
1536	Region VIII	Calbayog City	500238	Tabawan Integrated School	74
1537	Region VIII	Eastern Samar	122354	Sta. Rosa Elementary School	62
1538	Region VIII	Eastern Samar	122430	Caglao-an Elementary School	124
1539	Region VIII	Eastern Samar	122454	Hinolaso Elementary School	91
1540	Region VIII	Eastern Samar	122531	Alingarog Elementary School	71
1541	Region VIII	Eastern Samar	122565	Ngolos-Honeywell Elementary School	70
1542	Region VIII	Eastern Samar	122640	Kalaw Elementary School	97
1543	Region VIII	Eastern Samar	122651	Tawagan Elementary School	71
1544	Region VIII	Eastern Samar	122668	Oras West Central Elementary School	96
1545	Region VIII	Eastern Samar	122706	Bagtong Central Elementary School	67
1546	Region VIII	Eastern Samar	122769	Mantang Elementary School	77
1547	Region VIII	Eastern Samar	192509	Pangabutan Primary School	71
1548	Region VIII	Eastern Samar	192518	Tagporo Elementary School	82
1549	Region VIII	Eastern Samar	303495	Balangkayan National High School	72
1550	Region VIII	Eastern Samar	303503	Guiuan National High School	140
1551	Region VIII	Eastern Samar	303510	Jipapad National High School	83
1552	Region VIII	Eastern Samar	303512	Lawaan National School of Craftsmanship and Home Industries	118
1553	Region VIII	Eastern Samar	303514	Malabag National High School	85
1554	Region VIII	Eastern Samar	303521	Quinapondan National High School	89
1555	Region VIII	Eastern Samar	500823	Taytay Integrated School	66
1556	Region VIII	Leyte	120931	Matagnao Primary School	63
1557	Region VIII	Leyte	120949	Lingayon Elementary School	61
1558	Region VIII	Leyte	120963	Binongtoan Central School	106
1559	Region VIII	Leyte	120995	Antipolo Elementary School	83
1560	Region VIII	Leyte	120996	Balugo Elementary School	81
1561	Region VIII	Leyte	120998	Albuera South Central School	63
1562	Region VIII	Leyte	121000	Mahayahay Elementary School	77
1563	Region VIII	Leyte	121001	Salvacion Elementary School	122
1564	Region VIII	Leyte	121003	Tabgas Elementary School	80
1565	Region VIII	Leyte	121249	Sto. Niño Elementary School	72
1566	Region VIII	Leyte	121260	Cassidy Elementary School	86
1567	Region VIII	Leyte	121319	Bulod Elementary School	62
1568	Region VIII	Leyte	121325	Dacay Elementary School	75
1569	Region VIII	Leyte	121333	SAN ISIDRO ELEMENTARY SCHOOL	65
1570	Region VIII	Leyte	121336	Tabu Elementary School	67
1571	Region VIII	Leyte	121356	Bagumbayan Elementary School	94
1572	Region VIII	Leyte	121461	Jaro I Central Elementary School	66

No.	Region	Division	School ID	School Name	Sum of Total
1573	Region VIII	Leyte	121493	Batug Elementary School	87
1574	Region VIII	Leyte	121560	Buracan Elementary School	67
1575	Region VIII	Leyte	121568	Doyog Elementary School	66
1576	Region VIII	Leyte	121569	Gimiranat East Elementary School	63
1577	Region VIII	Leyte	121581	Piliway Primary School	68
1578	Region VIII	Leyte	121639	Mahaplag Central School	63
1579	Region VIII	Leyte	121704	Gen. A. Luna Primary School	61
1580	Region VIII	Leyte	121705	Liberty Elementary School	69
1581	Region VIII	Leyte	121707	Mayorga Central School	62
1582	Region VIII	Leyte	121799	Palompon South Central School	76
1583	Region VIII	Leyte	121829	Banat-i Elementary School	61
1584	Region VIII	Leyte	121849	Bahay Elementary School	67
1585	Region VIII	Leyte	121856	Impo Primary School	65
1586	Region VIII	Leyte	121876	SAN ISIDRO ELEMENTARY SCHOOL	65
1587	Region VIII	Leyte	191520	Ada Primary School	148
1588	Region VIII	Leyte	303343	Juan S. Tismo National High School (Babatngon National High School)	70
1589	Region VIII	Leyte	303352	Bung-aw National High School	65
1590	Region VIII	Leyte	303355	Cabacungan National High School	63
1591	Region VIII	Leyte	303367	Don Mariano Salvacion Memorial National High School	62
1592	Region VIII	Leyte	303373	Hampipila National High School	82
1593	Region VIII	Leyte	303382	Justimbaste-Remandaban National High School	61
1594	Region VIII	Leyte	303402	Marao National High School	97
1595	Region VIII	Leyte	303403	Marcelino R. Veloso National High School (Marcelino R. Veloso NHS)	66
1596	Region VIII	Leyte	303405	Matalom National High School	101
1597	Region VIII	Leyte	303407	Mayorga National High School	88
1598	Region VIII	Leyte	303415	Palo National High School	90
1599	Region VIII	Leyte	303418	Pinamopoan National High School	133
1600	Region VIII	Leyte	303423	San Isidro National High School	228
1601	Region VIII	Leyte	303424	San Joaquin National High School	71
1602	Region VIII	Leyte	303440	Tolosa National High School	162
1603	Region VIII	Leyte	313333	Jose Rizal National High School	101
1604	Region VIII	Leyte	313335	Pawing National High School	65
1605	Region VIII	Northern Samar	122808	J. A. Santos ES	71
1606	Region VIII	Northern Samar	122831	Binog ES	69
1607	Region VIII	Northern Samar	122836	Generoso R. Frigillana Memorial School	222
1608	Region VIII	Northern Samar	122875	Bongog Elementary School	65
1609	Region VIII	Northern Samar	122889	Opong ES	87
1610	Region VIII	Northern Samar	122893	Tongodnon ES	63
1611	Region VIII	Northern Samar	122908	Osang ES	64
1612	Region VIII	Northern Samar	123011	Del Pilar ES	79
1613	Region VIII	Northern Samar	123013	Enoman ES	98
1614	Region VIII	Northern Samar	123019	Hangi ES	86
1615	Region VIII	Northern Samar	123022	Lakandula Elementary School	73
1616	Region VIII	Northern Samar	123031	Matelarag Elementary	73
1617	Region VIII	Northern Samar	123044	San Fernando ES	88

No.	Region	Division	School ID	School Name	Sum of Total
1618	Region VIII	Northern Samar	123051	Tagab-Iran ES	83
1619	Region VIII	Northern Samar	123074	San Miguel ES	156
1620	Region VIII	Northern Samar	123079	VILLAHERMOSA ES	132
1621	Region VIII	Northern Samar	123092	Maghipid ES	62
1622	Region VIII	Northern Samar	123104	Burgos ES	82
1623	Region VIII	Northern Samar	123110	Pangudtan PS	147
1624	Region VIII	Northern Samar	123124	Imelda ES	65
1625	Region VIII	Northern Samar	123169	Busak ES	69
1626	Region VIII	Northern Samar	123173	Canjumadal ES	74
1627	Region VIII	Northern Samar	123175	Dona Anecita ES	62
1628	Region VIII	Northern Samar	123241	Lubog Primary School	65
1629	Region VIII	Northern Samar	123246	Maragat ES	62
1630	Region VIII	Northern Samar	123274	Erenas ES	74
1631	Region VIII	Northern Samar	193013	Barangay Uno Elementary School	70
1632	Region VIII	Northern Samar	303531	Allen National High School	106
1633	Region VIII	Northern Samar	303534	BIRI NATIONAL HIGH SCHOOL	111
1634	Region VIII	Northern Samar	303541	Catarman National High School	61
1635	Region VIII	Northern Samar	303543	Galutan NHS	77
1636	Region VIII	Northern Samar	303544	Catubig Valley NHS	67
1637	Region VIII	Northern Samar	303568	Nenita National High School	89
1638	Region VIII	Northern Samar	305584	Froctoso B. Regulacion National High School	67
1639	Region VIII	Northern Samar	313609	Cabatuan NHS	106
1640	Region VIII	Northern Samar	313624	Oleras NHS	62
1641	Region VIII	Ormoc City	124200	Airport Primary School	66
1642	Region VIII	Ormoc City	124211	JICA-Lao Elementary School	83
1643	Region VIII	Ormoc City	124212	Libertad Elementary School	75
1644	Region VIII	Ormoc City	124213	Licuma Elementary School	109
1645	Region VIII	Ormoc City	124220	San Juan Elementary School	66
1646	Region VIII	Ormoc City	303654	Dolores National High School	66
1647	Region VIII	Samar (Western Samar)	123285	Almagro Central Elementary School	82
1648	Region VIII	Samar (Western Samar)	123312	Burgos Elementary School	90
1649	Region VIII	Samar (Western Samar)	123318	Mabini Elementary School	72
1650	Region VIII	Samar (Western Samar)	123376	Macaalan Elementary School	66
1651	Region VIII	Samar (Western Samar)	123383	Panayuran Elementary School	87
1652	Region VIII	Samar (Western Samar)	123522	Rawis Elementary School	88
1653	Region VIII	Samar (Western Samar)	123542	Gandara II Central Elementary School	70
1654	Region VIII	Samar (Western Samar)	123637	Linonoban Elementary School	63
1655	Region VIII	Samar (Western Samar)	123640	Mararangsi Elementary School	62
1656	Region VIII	Samar (Western Samar)	123650	Bangon Elementary School	85
1657	Region VIII	Samar (Western Samar)	123800	Tulay Elementary School	66
1658	Region VIII	Samar (Western Samar)	123823	Nipa Elementary School	61
1659	Region VIII	Samar (Western Samar)	303589	Bagacay National High School	142
1660	Region VIII	Samar (Western Samar)	303593	Burgos Integrated School	129
1661	Region VIII	Samar (Western Samar)	303618	Ramon T. Diaz National High School	95
1662	Region VIII	Samar (Western Samar)	303626	San Jose de Buan National High School	154

No.	Region	Division	School ID	School Name	Sum of Total
1663	Region VIII	Samar (Western Samar)	303638	Villahermosa National High School	116
1664	Region VIII	Southern Leyte	122082	Mayuga Elementary School	68
1665	Region VIII	Southern Leyte	122216	Tigbawan Elementary School	62
1666	Region VIII	Southern Leyte	122258	Buac Elementary School	66
1667	Region VIII	Southern Leyte	122259	Cabadbaran PS	176
1668	Region VIII	Southern Leyte	122263	Hindangan PS	188
1669	Region VIII	Southern Leyte	122267	Kauswagan Elementary School	285
1670	Region VIII	Southern Leyte	122268	Libas Elementary School	182
1671	Region VIII	Southern Leyte	122272	Milagroso Elementary School	176
1672	Region VIII	Southern Leyte	122276	Rizal Primary School	339
1673	Region VIII	Southern Leyte	122279	San Pedro Elementary School	195
1674	Region VIII	Southern Leyte	122280	Sogod Central School	189
1675	Region VIII	Southern Leyte	122281	Sta. Maria Primary School	189
1676	Region VIII	Southern Leyte	122293	Lipanto Elementary School	106
1677	Region VIII	Southern Leyte	192027	Lum-an Multigrade School	181
1678	Region VIII	Southern Leyte	192033	Mabicay Elementary School	172
1679	Region VIII	Southern Leyte	303447	Hinunangan National High School	106
1680	Region VIII	Southern Leyte	303463	Libas NATIONAL HIGH SCHOOL	347
1681	Region VIII	Southern Leyte	303487	Sogod National High School	345
1682	Region VIII	Tacloban City	124230	V & G Memorial School	76
1683	Region VIII	Tacloban City	124241	Sto. Nino Elementary School	65
1684	Region VIII	Tacloban City	124249	San Fernando Central School	99
1685	Region VIII	Tacloban City	124256	City Central School	62
1686	Region VIII	Tacloban City	330503	V&G National High School	61
1687	Region X	Bukidnon	126329	Kapalaran Elementary school	1,375
1688	Region X	Bukidnon	126459	Bagong Silang ES	77
1689	Region X	Bukidnon	126683	JARQUE ES	61
1690	Region X	Bukidnon	126702	San Miguel ES	94
1691	Region X	Bukidnon	126707	Butong ES	114
1692	Region X	Bukidnon	126747	Bonacao ES	70
1693	Region X	Bukidnon	126753	Halapitan CES	73
1694	Region X	Bukidnon	126767	Matupe ES	61
1695	Region X	Bukidnon	303960	KIBAWA NATIONAL HIGH SCHOOL	84
1696	Region X	Bukidnon	303985	Sinuda National High School	781
1697	Region X	Bukidnon	314901	Dalirig NHS	90
1698	Region X	Bukidnon	500682	White Kulaman Integrated School	64
1699	Region X	Cagayan de Oro City	304109	Canitoan National High School	69
1700	Region X	Cagayan de Oro City	304123	Tignapoloan National High School	80
1701	Region X	Cagayan de Oro City	304125	Taglimao National High School	62
1702	Region X	Cagayan de Oro City	304127	Tagpangi National High School	68
1703	Region X	Camiguin	500683	Alangilan Integrated School	543
1704	Region X	El Salvador	315305	MOLUGAN NATIONAL HIGH SCHOOL	71
1705	Region X	Gingog City	128067	Kibuging Elementary School	80
1706	Region X	Iligan City	128135	Rufino Mangilisan MES (Tablon ES)	82
1707	Region X	Lanao del Norte	126974	Patpangkat PS	137

No.	Region	Division	School ID	School Name	Sum of Total
1708	Region X	Lanao del Norte	126985	Raw-an Point ES	134
1709	Region X	Lanao del Norte	126998	San Vicente ES	104
1710	Region X	Lanao del Norte	127005	CONCEPCION ELEMENTARY SCHOOL	91
1711	Region X	Lanao del Norte	127009	Sixto Maghanoy Sr. Central School	64
1712	Region X	Lanao del Norte	127011	SAN ISIDRO ELEMENTARY SCHOOL	84
1713	Region X	Lanao del Norte	304014	Munai NHS	101
1714	Region X	Lanao del Norte	304021	Tagoloan NHS	81
1715	Region X	Misamis Occidental	127389	Carmen Annex PS	147
1716	Region X	Misamis Occidental	127405	Tabo-o ES - Tabo-o PS (Annex)	87
1717	Region X	Misamis Occidental	127578	Silongon Elementary School	72
1718	Region X	Misamis Occidental	304033	Concepcion NHS	73
1719	Region X	Misamis Occidental	501654	Carmen Integrated School	185
1720	Region X	Misamis Oriental	127618	Lapu-Lapu ES	74
1721	Region X	Misamis Oriental	127783	Kibungsod CS	86
1722	Region X	Misamis Oriental	127820	Labas-Pagsama ES	62
1723	Region X	Misamis Oriental	304066	Consuelo NHS	61
1724	Region X	Misamis Oriental	304071	Hinaplanan NHS	71
1725	Region X	Misamis Oriental	304091	Misamis Oriental General Comprehensive High School	92
1726	Region X	Ozamis City	128166	Catadman Elementary School	68
1727	Region X	Tangub City	323302	Simasay National High School	66
1728	Region X	Valencia City	126857	Sinalayan ES	210
1729	Region XI	Davao City	129519	T. Awad Echevarria ES	64
1730	Region XI	Davao City	129556	Doña Pilar L. Marfori ES	63
1731	Region XI	Davao City	129592	Malabog CES	93
1732	Region XI	Davao City	129687	Mulig Elementary School	63
1733	Region XI	Davao City	129720	Jose Bastida ES	65
1734	Region XI	Davao City	304341	ALEJANDRA L. NAVARRO NHS	77
1735	Region XI	Davao City	304342	Ma. Cristina P. Belcar Agricultural High School	66
1736	Region XI	Davao City	304357	E. B. Lopez Mem. NHS	134
1737	Region XI	Davao City	304363	Davao City Special National High School	71
1738	Region XI	Davao City	304366	F. Bangoy NHS	61
1739	Region XI	Davao City	304378	GOV. VICENTE DUTERTE NATIONAL HIGH SCHOOL	74
1740	Region XI	Davao City	304381	Marilog High School of Agriculture (Tech-Voc School)	111
1741	Region XI	Davao City	304383	G.Astilla Sr. Cultural Minority HS	64
1742	Region XI	Davao City	304390	Panaga National High School	102
1743	Region XI	Davao City	304392	Sirib NHS	90
1744	Region XI	Davao City	316202	Catalunan Pequeno National High School	98
1745	Region XI	Davao De Oro	128294	Datu Davao ES	89
1746	Region XI	Davao De Oro	128373	New Leyte ES	66
1747	Region XI	Davao De Oro	128425	Babag ES	67
1748	Region XI	Davao De Oro	128523	Pagsabangan ES	71
1749	Region XI	Davao De Oro	128545	Lahi ES	82
1750	Region XI	Davao De Oro	128547	Liniputan ES	104
1751	Region XI	Davao De Oro	128548	Magnaga ES	67
1752	Region XI	Davao De Oro	300640	Camansi National High School	61

No.	Region	Division	School ID	School Name	Sum of Total
1753	Region XI	Davao De Oro	304205	Nabunturan NCHS	61
1754	Region XI	Davao De Oro	304211	Tambongon NHS	77
1755	Region XI	Davao del Norte	128572	Canatan Elementary School	79
1756	Region XI	Davao del Norte	128650	Dugayan ES	100
1757	Region XI	Davao del Norte	128666	Patel Elementary School	82
1758	Region XI	Davao del Norte	204505	Dibabawon I Elementary School	93
1759	Region XI	Davao del Norte	204506	Dibabawon II ES	82
1760	Region XI	Davao del Norte	204508	BAROBO ELEMENTARY SCOOOL	67
1761	Region XI	Davao del Norte	304218	Sagayan NHS	65
1762	Region XI	Davao del Norte	304248	New Corella National High School	91
1763	Region XI	Davao del Norte	304254	Sto Tomas NHS	73
1764	Region XI	Davao del Norte	500448	Nasilaban Integrated School	62
1765	Region XI	Davao del Norte	501661	Manguangan Integrated School	90
1766	Region XI	Davao del Sur	128912	Nodilla Elementary School	65
1767	Region XI	Davao del Sur	129018	New Katipunan Elementary School	200
1768	Region XI	Davao del Sur	129098	Sinoron Elementary School	105
1769	Region XI	Davao del Sur	304278	Inawayan National High School	111
1770	Region XI	Davao del Sur	316016	Maria Clela R. Delos Cientos National High School	111
1771	Region XI	Davao Occidental	128847	Mabuhay Elementary School	81
1772	Region XI	Davao Occidental	128848	Maltusan Elementary School	82
1773	Region XI	Davao Occidental	128992	Macalanggan Sarway Sumanday ES	87
1774	Region XI	Davao Occidental	205025	Kangko ES	118
1775	Region XI	Davao Occidental	205029	Sitio Guisok BEAM Primary School	66
1776	Region XI	Davao Occidental	205032	TFS-Makalong ES	61
1777	Region XI	Davao Occidental	205040	TFS-Kamugna ES	70
1778	Region XI	Davao Occidental	205042	TFS-Kalamagan	63
1779	Region XI	Davao Occidental	205047	Kalabunay ES	88
1780	Region XI	Davao Occidental	205056	Malandog PS	95
1781	Region XI	Davao Occidental	302772	Tomas Lim Alcorido Sr. National High School	494
1782	Region XI	Davao Occidental	304266	Basiawan NHS	186
1783	Region XI	Davao Occidental	304267	Fishing Village Comprehensive NHS	98
1784	Region XI	Davao Occidental	304269	Fulong Maliona M. San Sr. National High School	97
1785	Region XI	Davao Occidental	304271	Demolok Valley National High School	89
1786	Region XI	Davao Occidental	304281	Jose Abad Santos NHS	77
1787	Region XI	Davao Occidental	304287	Mariano Peralta National High School	67
1788	Region XI	Davao Occidental	304292	John Martin Johnson High School (Lamidan)	98
1789	Region XI	Davao Occidental	316018	Pedro Mariscal National High School	159
1790	Region XI	Davao Occidental	501415	Harden Joyce Integrated School	63
1791	Region XI	Davao Oriental	129180	Causwagan Elementary School	64
1792	Region XI	Davao Oriental	129272	San Miguel Elementary School	64
1793	Region XI	Davao Oriental	129279	Badiang Elementary School	245
1794	Region XI	Davao Oriental	129280	Bonifacio Elementary School	299
1795	Region XI	Davao Oriental	129283	Enrique Orenacia Elementary School	283
1796	Region XI	Davao Oriental	129284	Osmeña Elementary School	285
1797	Region XI	Davao Oriental	129286	Sigaboy CES	294

No.	Region	Division	School ID	School Name	Sum of Total
1798	Region XI	Davao Oriental	129287	Tandang Sora Elementary School	289
1799	Region XI	Davao Oriental	129303	Calasagan Elementary School	64
1800	Region XI	Davao Oriental	129306	Immaculada Elementary School	72
1801	Region XI	Davao Oriental	129308	Kauswagan Elementary School	66
1802	Region XI	Davao Oriental	129318	Pangyan Elementary School	66
1803	Region XI	Davao Oriental	129456	Maliongan Elementary School	88
1804	Region XI	Davao Oriental	205505	Sigang ES	84
1805	Region XI	Davao Oriental	304330	Pundaguitan National High School	118
1806	Region XI	Davao Oriental	304331	Puntalinao National High School	87
1807	Region XI	Davao Oriental	304336	Sigaboy Agri. Voc. HS	1,291
1808	Region XI	Davao Oriental	304340	Tibanban National High School	221
1809	Region XI	Davao Oriental	316101	Marayag National High School	69
1810	Region XI	Davao Oriental	316109	Tagboa Agri-Vocational High School	68
1811	Region XI	Davao Oriental	500457	Maylaya Integrated School	87
1812	Region XI	Digos City	316302	Matti NHS	72
1813	Region XI	Mati City	101813	Bugakan Elementary School	65
1814	Region XI	Mati City	102164	Talucanga Elementary School	61
1815	Region XI	Mati City	129384	Sudlon Elementary School	64
1816	Region XI	Mati City	304338	Taguibo Agri. Voc. High School	78
1817	Region XI	Mati City	325104	Badas NHS	103
1818	Region XI	Mati City	501424	Culian Integrated School	76
1819	Region XI	Tagum City	304238	La Filipina NHS	75
1820	Region XI	Tagum City	500424	Busaon Integrated School	88
1821	Region XII	General Santos City	131272	Jose Catolico Sr. Elementary School	77
1822	Region XII	General Santos City	131314	Pedro Acharon Sr. Central Elementary School	68
1823	Region XII	Kidapawan City	131325	Datu Saliman Elementary School	130
1824	Region XII	Kidapawan City	131326	Kidapawan City Pilot Elementary School	131
1825	Region XII	Kidapawan City	131328	Suerte MES	135
1826	Region XII	Kidapawan City	131329	Balabag ES	133
1827	Region XII	Kidapawan City	131331	Cayetano A. Javier Memorial Elementary School	123
1828	Region XII	Kidapawan City	131332	Ginatilan Elementary School	133
1829	Region XII	Kidapawan City	131334	Manongol Central Elementary School	136
1830	Region XII	Kidapawan City	131335	Meohao Elementary School	134
1831	Region XII	Kidapawan City	131337	Perez Elementary School	132
1832	Region XII	Kidapawan City	131338	Sayaban Elementary School	145
1833	Region XII	Kidapawan City	131339	Sibug Memorial Elementary School	142
1834	Region XII	Kidapawan City	131340	Sumayahon Elementary School	146
1835	Region XII	Kidapawan City	131341	Lapan Elementary School	138
1836	Region XII	Kidapawan City	131343	Kalasuyan ES	142
1837	Region XII	Kidapawan City	131344	Lanao Central Elementary School	144
1838	Region XII	Kidapawan City	131345	Luvimin Elementary School	133
1839	Region XII	Kidapawan City	131348	Mateo Elementary School	135
1840	Region XII	Kidapawan City	131349	Sibawan Elementary School	145
1841	Region XII	Kidapawan City	131351	Calaoacan ES	141
1842	Region XII	Kidapawan City	131353	Kalaisan Elementary School	136

No.	Region	Division	School ID	School Name	Sum of Total
1843	Region XII	Kidapawan City	131354	Mateo Olodin Memorial Elementary School	132
1844	Region XII	Kidapawan City	131356	San Miguel Elementary School	130
1845	Region XII	Kidapawan City	131358	Paco Central Elementary School	133
1846	Region XII	Kidapawan City	131359	Sikitan Elementary School	141
1847	Region XII	Kidapawan City	131360	Sto. Niño Elementary School	135
1848	Region XII	Kidapawan City	131361	Sumbac Elementary School	129
1849	Region XII	Kidapawan City	131362	Amas CES	134
1850	Region XII	Kidapawan City	131363	Amazion Elementary School	133
1851	Region XII	Kidapawan City	131365	Gayola ES	131
1852	Region XII	Kidapawan City	131366	Katipunan Elementary School	125
1853	Region XII	Kidapawan City	131367	Malinan Elementary School	133
1854	Region XII	Kidapawan City	131368	Onica Elementary School	134
1855	Region XII	Kidapawan City	131371	San Isidro ES	132
1856	Region XII	Kidapawan City	131372	San Roque ES	136
1857	Region XII	Kidapawan City	210501	Datu Pananggom E. Andagkit Memorial Elementary School	142
1858	Region XII	Kidapawan City	210502	Ray Buenaventura A. Sabulao Memorial Elementary School	136
1859	Region XII	Kidapawan City	210503	UPPER SINGAO ELEM. SCHOOL	131
1860	Region XII	Kidapawan City	210504	Habitat Elementary School	137
1861	Region XII	Kidapawan City	210505	Bangsamoro ES	133
1862	Region XII	Kidapawan City	281513	Datu Ambas Manib IP School	130
1863	Region XII	Kidapawan City	281514	Datu Domingo Ongcas IP School	133
1864	Region XII	Kidapawan City	304657	Gayola National High School	260
1865	Region XII	Kidapawan City	304658	Ginatilan National High School	279
1866	Region XII	Kidapawan City	304659	Manongol National High School	286
1867	Region XII	Kidapawan City	304661	Kidapawan City National High School	264
1868	Region XII	Kidapawan City	304663	Kalaisan National High School	257
1869	Region XII	Kidapawan City	304664	Mt. Apo National High School	260
1870	Region XII	Kidapawan City	304665	Saniel Cruz National High School	268
1871	Region XII	Kidapawan City	304666	Spottswood NHS	262
1872	Region XII	Kidapawan City	304667	Onica National High School	263
1873	Region XII	Kidapawan City	305749	LANAO NATIONAL HIGH SCHOOL	130
1874	Region XII	Kidapawan City	317101	Linangkob National High School	291
1875	Region XII	Kidapawan City	317102	Juan L. Gantuangco School of Arts and Trades	280
1876	Region XII	Kidapawan City	317103	Patadon National High School	269
1877	Region XII	Kidapawan City	500303	Lake Agco Integrated School	283
1878	Region XII	Kidapawan City	500304	Macebolig Integrated School	386
1879	Region XII	Kidapawan City	500305	Marciano Mancera Integrated School	385
1880	Region XII	Kidapawan City	500306	Mua-an Integrated School	264
1881	Region XII	Kidapawan City	500307	Singao Integrated School	399
1882	Region XII	Kidapawan City	500308	Nuangan Integrated School	273
1883	Region XII	Kidapawan City	500309	Binoligan Integrated School	384
1884	Region XII	North Cotabato	100922	Braulio G. Dano Elementary School	106
1885	Region XII	North Cotabato	129835	Badak Elementary School	88
1886	Region XII	North Cotabato	129882	Datu Embangan PS	95
1887	Region XII	North Cotabato	129931	Balindong PS	62

No.	Region	Division	School ID	School Name	Sum of Total
1888	Region XII	North Cotabato	129934	Capayangan ES	66
1889	Region XII	North Cotabato	129935	Carugmanan ES	61
1890	Region XII	North Cotabato	129936	Gastav Elementary School	64
1891	Region XII	North Cotabato	129937	Kalawaig Elementary School	65
1892	Region XII	North Cotabato	129938	Kiaring ES	92
1893	Region XII	North Cotabato	129940	M. Macasarte ES	71
1894	Region XII	North Cotabato	129941	Malagap ES	79
1895	Region XII	North Cotabato	129943	Malinao CES	70
1896	Region XII	North Cotabato	129949	Riverside ES	65
1897	Region XII	North Cotabato	129952	Thailand Elementary School	62
1898	Region XII	North Cotabato	129954	Tumbao ES	64
1899	Region XII	North Cotabato	130024	USM ANNEX CENTRAL ELEMENTARY SCHOOL	75
1900	Region XII	North Cotabato	130057	Kinarum ES	93
1901	Region XII	North Cotabato	130083	ASUNCION ELEMENTARY SCHOOL	85
1902	Region XII	North Cotabato	130084	Balawan Elementary School	92
1903	Region XII	North Cotabato	130085	INDANGAN ELEMENTARY SCHOOL	88
1904	Region XII	North Cotabato	130087	KATIPUNAN 1 ELEMENTARY SCHOOL	116
1905	Region XII	North Cotabato	130088	Makilala Central Elementary School	86
1906	Region XII	North Cotabato	130089	MALASILA ELEMENTARY SCHOOL	80
1907	Region XII	North Cotabato	130090	New Cebu Elementary School	84
1908	Region XII	North Cotabato	130091	Saguing CES	85
1909	Region XII	North Cotabato	130094	Biangan Elementary School	83
1910	Region XII	North Cotabato	130096	BUHAY ELEMENTARY SCHOOL	92
1911	Region XII	North Cotabato	130097	Bulatukan ES	89
1912	Region XII	North Cotabato	130098	Garsika Elementary School	113
1913	Region XII	North Cotabato	130101	Luayon ES (Garing)	104
1914	Region XII	North Cotabato	130103	New Israel ES	82
1915	Region XII	North Cotabato	130104	Rodero ES	72
1916	Region XII	North Cotabato	130105	SAN ISIDRO ELEMENTARY SHOOOL	81
1917	Region XII	North Cotabato	130106	Sta. Felomina ES	110
1918	Region XII	North Cotabato	130107	Sto. Nino ES	95
1919	Region XII	North Cotabato	130110	CONCEPCION ELEMENTARY SCHOOL	91
1920	Region XII	North Cotabato	130113	JOSE RIZAL ELEMENTARY	86
1921	Region XII	North Cotabato	130114	Katipunan II Elementary School	102
1922	Region XII	North Cotabato	130117	Libertad ES	84
1923	Region XII	North Cotabato	130124	Sinkatulan Elementary School	83
1924	Region XII	North Cotabato	130156	Leonard Elemantary School	103
1925	Region XII	North Cotabato	130214	LOMOPOG ELEMENTARY SCHOOL	95
1926	Region XII	North Cotabato	130216	Macasendeg ES	79
1927	Region XII	North Cotabato	130400	Bacong ES	66
1928	Region XII	North Cotabato	207540	Kalalagan Elementary School	72
1929	Region XII	North Cotabato	207545	Dilanggalen ES	67
1930	Region XII	North Cotabato	207558	Agustin Doneza ES	76
1931	Region XII	North Cotabato	207560	Sitio Mainit ES	92
1932	Region XII	North Cotabato	207566	Lower Saguing Elementary School	83

No.	Region	Division	School ID	School Name	Sum of Total
1933	Region XII	North Cotabato	304419	Banayal HS	89
1934	Region XII	North Cotabato	304422	BASAK NATIONAL HIGH SCHOOL	89
1935	Region XII	North Cotabato	304444	Kabacan National High School	66
1936	Region XII	North Cotabato	304458	Kitub-Bao NHS	78
1937	Region XII	North Cotabato	304505	Silik High School	78
1938	Region XII	North Cotabato	316507	Agustin M. Valdevieso, Sr. High School	64
1939	Region XII	North Cotabato	316549	Tukuran T. Kendenga High School	66
1940	Region XII	North Cotabato	316550	Datu Bitol Mangansakan Memorial High School	135
1941	Region XII	Sarangani	130427	Kiangkos Elementary School	64
1942	Region XII	Sarangani	130506	Mamangos Maulana Kandog ES	61
1943	Region XII	Sarangani	130551	Del Hilado ES	68
1944	Region XII	Sarangani	130562	Malkahi Elementary School	178
1945	Region XII	Sarangani	130567	Tocablao ES	69
1946	Region XII	Sarangani	208037	D. Masalon Y. Recto ES	78
1947	Region XII	Sarangani	304517	Alabel National Science High School	93
1948	Region XII	Sarangani	304518	Alabel National High School	90
1949	Region XII	Sarangani	304525	Glan-Padidu NHS	66
1950	Region XII	Sarangani	304530	Leonard Young Sr. National High School	72
1951	Region XII	Sarangani	304531	Lun Padidu National High School	146
1952	Region XII	Sarangani	304538	Malungon National High School	75
1953	Region XII	Sarangani	316606	Aniceto C. Lopez Sr. NHS	158
1954	Region XII	Sarangani	316639	Malalag NHS - Upo Annex	76
1955	Region XII	Sarangani	500256	Datal Anggas IS	89
1956	Region XII	Sarangani	500257	New Canaan Integrated School	74
1957	Region XII	Sarangani	500261	Roque Adarna Integrated School	131
1958	Region XII	Sarangani	500265	Datu Molod IS	97
1959	Region XII	Sarangani	500269	Upper Lumabat IS	86
1960	Region XII	Sarangani	500270	Datal Batong Integrated School	79
1961	Region XII	Sarangani	500272	Daan Suyan Integrated School	143
1962	Region XII	Sarangani	500274	Kyumad Integrated School	120
1963	Region XII	Sarangani	500276	Tangan Integrated School	128
1964	Region XII	Sarangani	500279	Malabod Integrated School	93
1965	Region XII	Sarangani	500286	Leopoldo D. Dacera Sr. IS	527
1966	Region XII	Sarangani	500301	Kiahe Integrated School	94
1967	Region XII	Sarangani	500713	San Juan Integrated School	99
1968	Region XII	Sarangani	500715	Lamlifew Integrated School	83
1969	Region XII	Sarangani	500835	Dakok Tamulon Integrated School	111
1970	Region XII	South Cotabato	130854	Danlag Elementary School	88
1971	Region XII	South Cotabato	208503	Coong Elementary School	62
1972	Region XII	South Cotabato	281569	Datu Kahar Macasayon Elementary School	159
1973	Region XII	South Cotabato	316725	Upper Maculan National High School	103
1974	Region XII	Sultan Kudarat	131085	Pinguiaman Elementary School	154
1975	Region XII	Sultan Kudarat	131087	Udtong Elementary School	75
1976	Region XII	Sultan Kudarat	131105	Tinumigues Elementary School	76
1977	Region XII	Sultan Kudarat	131114	Pansud Elementary School	61

No.	Region	Division	School ID	School Name	Sum of Total
1978	Region XII	Sultan Kudarat	131142	Posadas Elementary School	143
1979	Region XII	Sultan Kudarat	304580	Bagumbayan National High School	71
1980	Region XII	Sultan Kudarat	304589	Esperanza National High School	69
1981	Region XII	Sultan Kudarat	304591	Kalamansig National High School	81
1982	Region XII	Sultan Kudarat	304611	Baluan National High School	77
1983	Region XII	Sultan Kudarat	304613	New Panay National High School	82
1984	Region XII	Sultan Kudarat	304623	Sta. Clara National High School	65
1985	Region XII	Sultan Kudarat	500723	Tapudi Integrated School	72
1986	Region XII	Sultan Kudarat	500761	Upper Bunawan Integrated School	191
1987	Region XII	Sultan Kudarat	500946	Artemio L. Martin Integrated School	114
1988	Region XII	Sultan Kudarat	501174	Datu Ito Andong Integrated School	137



PROPOSED TEMPORARY LEARNING SPACE
EXTERIOR PERSPECTIVE 1

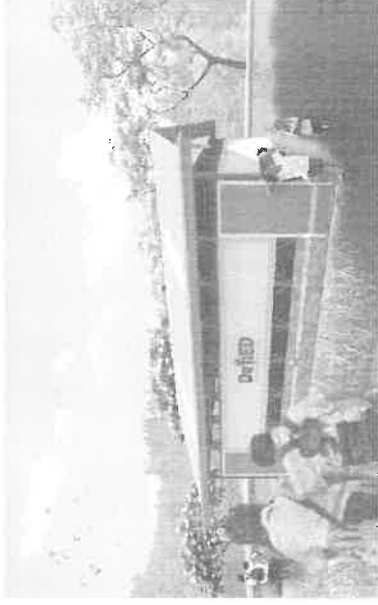

PROPOSED TEMPORARY LEARNING SPACE
EXTERIOR PERSPECTIVE 2



PROPOSED TEMPORARY LEARNING SPACE
INTERIOR PERSPECTIVE 2



PROPOSED TEMPORARY LEARNING SPACE
INTERIOR PERSPECTIVE 1

 <p>DEPARTMENT OF EDUCATION Division Office - Marikina City</p>	<p>PREPARED BY: <i>[Signature]</i> ARCHITECT DATE: 12/15/2023</p>	<p>DATE: 12/15/2023 PROJECT NO. 2023-001</p>	<p>REVISIONS: NONE</p>	<p>APPROVED BY: <i>[Signature]</i> PROJECT TITLE: PROPOSED TEMPORARY LEARNING SPACE</p>	<p>DEPARTMENT OF EDUCATION Division Office - Marikina City</p>	<p>PROJECT NO. 2023-001 PROJECT TITLE: PROPOSED TEMPORARY LEARNING SPACE</p>	<p>DATE: 12/15/2023 PROJECT NO. 2023-001</p>	<p>PROJECT NO. 2023-001 PROJECT TITLE: PROPOSED TEMPORARY LEARNING SPACE</p>	<p>PROJECT NO. 2023-001 PROJECT TITLE: PROPOSED TEMPORARY LEARNING SPACE</p>
--	---	--	------------------------	---	--	--	--	--	--

SCHEDULE OF WOOD COMPONENTS

COMPONENT	SPECIFICATIONS
FRAMING	100mm x 150mm C.O.C.O LUMBER
BEAM	50mm x 70mm C.O.C.O LUMBER
RAFTER	50mm x 70mm C.O.C.O LUMBER
PARTIAL JOIST	50mm x 70mm C.O.C.O LUMBER
PLATE	50mm x 70mm C.O.C.O LUMBER
DIAGONAL WALL STUD	50mm x 70mm C.O.C.O LUMBER

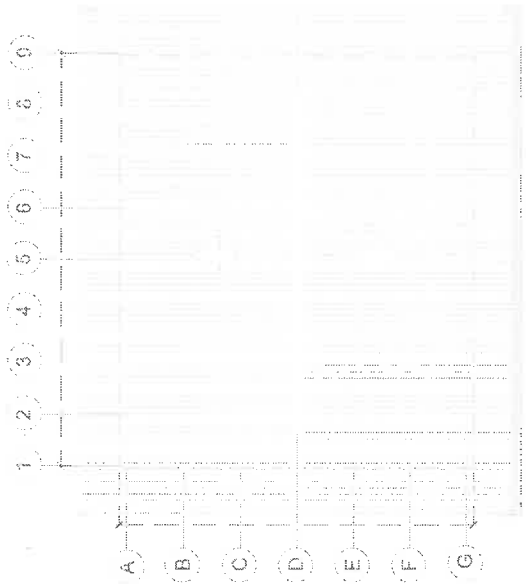
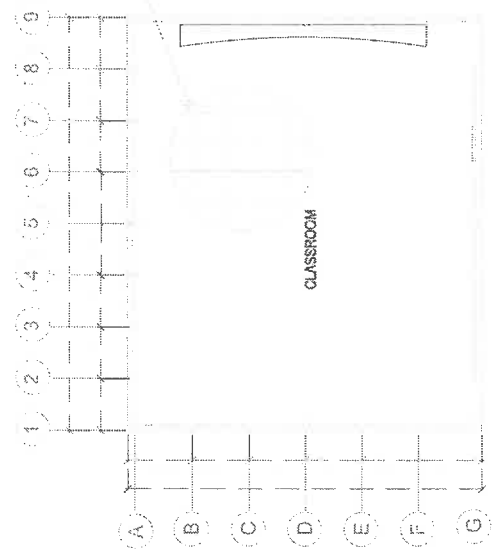

 <p>DEPARTMENT OF EDUCATION BUREAU OF TECHNICAL EDUCATION</p>	<p>PROJECT TITLE PROPOSED TEMPORARY LEARNING SPACE</p>	<p>PROJECT NO. DEPED-2023-001</p>	<p>DATE 10/25/23</p>	<p>PROJECT NO. DEPED-2023-001</p>	<p>PROJECT TITLE PROPOSED TEMPORARY LEARNING SPACE</p>	<p>PROJECT NO. DEPED-2023-001</p>	<p>PROJECT TITLE PROPOSED TEMPORARY LEARNING SPACE</p>	<p>PROJECT NO. DEPED-2023-001</p>
<p>PROJECT NO. DEPED-2023-001</p>	<p>PROJECT TITLE PROPOSED TEMPORARY LEARNING SPACE</p>	<p>PROJECT NO. DEPED-2023-001</p>	<p>PROJECT TITLE PROPOSED TEMPORARY LEARNING SPACE</p>	<p>PROJECT NO. DEPED-2023-001</p>	<p>PROJECT TITLE PROPOSED TEMPORARY LEARNING SPACE</p>	<p>PROJECT NO. DEPED-2023-001</p>	<p>PROJECT TITLE PROPOSED TEMPORARY LEARNING SPACE</p>	<p>PROJECT NO. DEPED-2023-001</p>

SCHEDULE OF WOOD COMPONENTS

COMPONENT	SPECIFICATIONS
COLUMN	100 mm x 100 mm COCO LUMBER
POST	50 mm x 75 mm COCO LUMBER
BEAM	100 mm x 150 mm COCO LUMBER
RAFTER	100 mm x 150 mm COCO LUMBER
RAFTER COLLAR	50 mm x 75 mm COCO LUMBER
PURLINS	50 mm x 75 mm COCO LUMBER
DIAGONAL WALL STUD	50 mm x 75 mm COCO LUMBER

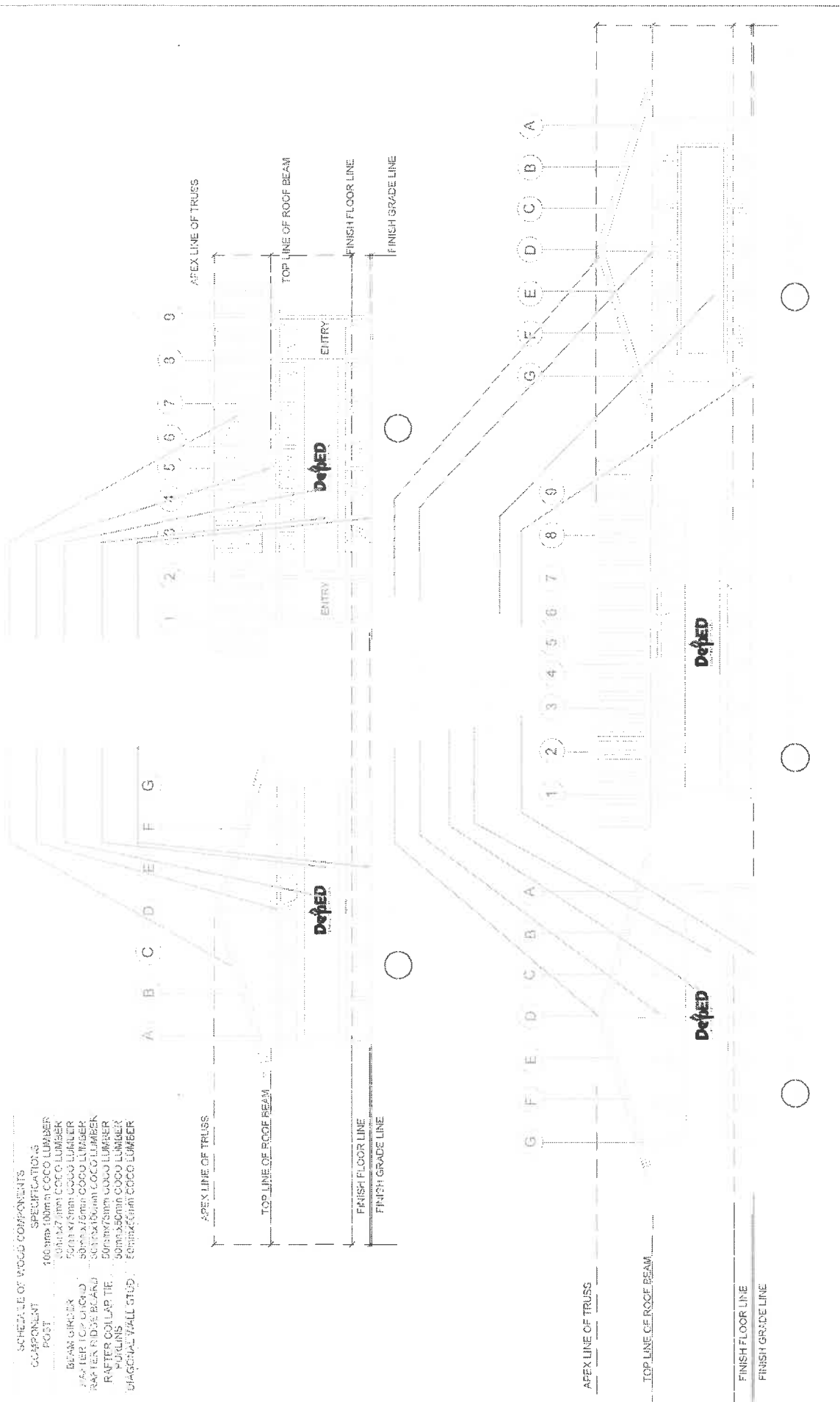

<p>PROJECT NO. 2023-PPRP-TURNAL 3</p> <p>DATE: 06/20/23</p>	<p>REVISIONS</p> <p>REVISION NO. 1: REVISION DESCRIPTION</p>	<p>DATE: 06/20/23</p> <p>PROJECT NO. 2023-PPRP-TURNAL 3</p>	<p>PROJECT TITLE</p> <p>PROPOSED TEMPORARY LEARNING SPACE</p>	<p>APPROVED BY:</p> <p>ASST. DIR. FOR ADMIN. SERVICES</p>	<p>RECOMMENDED APPROVAL:</p> <p>EDUCATION DIVISION</p>	<p>DATE: 06/20/23</p> <p>PROJECT NO. 2023-PPRP-TURNAL 3</p>	<p>DEPARTMENT OF EDUCATION</p> <p>DePEd</p>	<p>PROJECT NO. 2023-PPRP-TURNAL 3</p> <p>DATE: 06/20/23</p>
	<p>PROJECT NO. 2023-PPRP-TURNAL 3</p> <p>DATE: 06/20/23</p>							

SCHEDULE OF WOOD COMPONENTS

COMPONENT	SPECIFICATIONS
POST	16mmx16mm COCO LUMBER
BEAM GIRDER	50mmx75mm COCO LUMBER
RAFTER TOP RIB	50mmx75mm COCO LUMBER
RAFTER RIBS	50mmx75mm COCO LUMBER
RAFTER COLLAR TIE	50mmx75mm COCO LUMBER
PURLINS	50mmx75mm COCO LUMBER
DIAGONAL WALL STILD	50mmx75mm COCO LUMBER

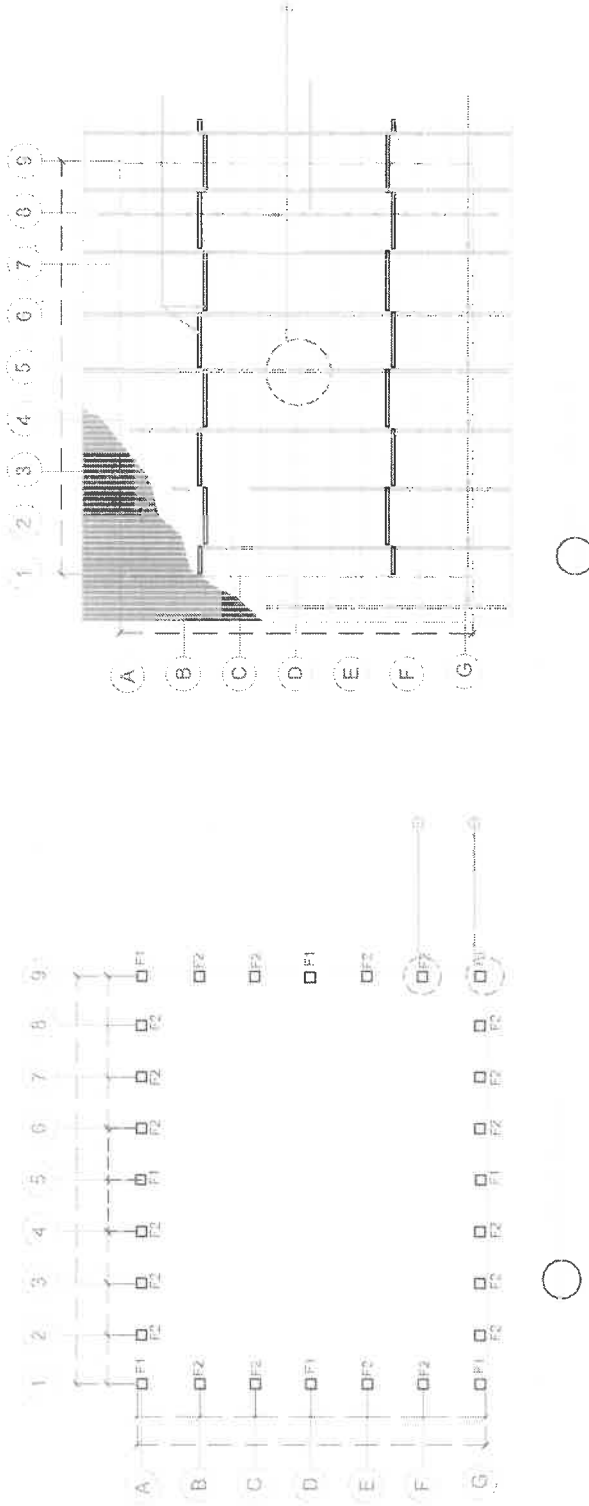

<p>DEPED DIVISION OFFICE - MARIKINA CITY DEPARTMENT OF EDUCATION OFFICE OF THE DIVISION SUPERVISOR</p>	<p>PROJECT NO. 1</p> <p>PROJECT TITLE PROPOSED TEMPORARY LEARNING SPACE</p>	<p>DESIGNED BY ARCHITECT DEPARTMENT OF ARCHITECTURE UNIVERSITY OF THE PHILIPPINES - MARIKINA CITY</p>	<p>DATE OF DESIGN</p>	<p>PROJECT NO. 1</p> <p>PROJECT TITLE PROPOSED TEMPORARY LEARNING SPACE</p>	<p>DESIGNED BY ARCHITECT DEPARTMENT OF ARCHITECTURE UNIVERSITY OF THE PHILIPPINES - MARIKINA CITY</p>	<p>DATE OF DESIGN</p>	<p>PROJECT NO. 1</p> <p>PROJECT TITLE PROPOSED TEMPORARY LEARNING SPACE</p>	<p>DESIGNED BY ARCHITECT DEPARTMENT OF ARCHITECTURE UNIVERSITY OF THE PHILIPPINES - MARIKINA CITY</p>	<p>DATE OF DESIGN</p>	<p>PROJECT NO. 1</p> <p>PROJECT TITLE PROPOSED TEMPORARY LEARNING SPACE</p>	<p>DESIGNED BY ARCHITECT DEPARTMENT OF ARCHITECTURE UNIVERSITY OF THE PHILIPPINES - MARIKINA CITY</p>	<p>DATE OF DESIGN</p>
<p>REVISIONS</p>												
<p>APPROVED BY: _____ DATE: _____</p>												
<p>PROJECT NO. 1</p> <p>PROJECT TITLE PROPOSED TEMPORARY LEARNING SPACE</p>												
<p>DESIGNED BY: _____ DATE: _____</p>												
<p>PROJECT NO. 1</p> <p>PROJECT TITLE PROPOSED TEMPORARY LEARNING SPACE</p>												
<p>DESIGNED BY: _____ DATE: _____</p>												
<p>PROJECT NO. 1</p> <p>PROJECT TITLE PROPOSED TEMPORARY LEARNING SPACE</p>												
<p>DESIGNED BY: _____ DATE: _____</p>												
<p>PROJECT NO. 1</p> <p>PROJECT TITLE PROPOSED TEMPORARY LEARNING SPACE</p>												
<p>DESIGNED BY: _____ DATE: _____</p>												

SCHEDULE OF WOOD COMPONENTS

COMPONENT	SPECIFICATIONS
POST	100mm x 100mm COCO LUMBER
BEAM GIRDER	50mm x 75mm COCO LUMBER
RAFTER TOP CHORD	50mm x 75mm COCO LUMBER
RAFTER PADDE BOARD	50mm x 75mm COCO LUMBER
RAFTER COLLAR TIE	50mm x 75mm COCO LUMBER
FURLINS	50mm x 50mm COCO LUMBER
DIAGONAL WALL STUD	50mm x 50mm COCO LUMBER

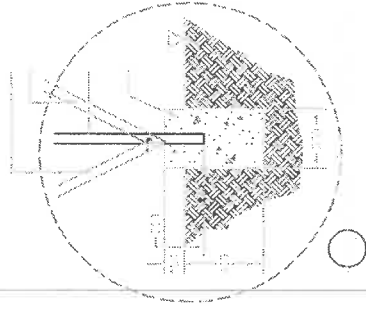
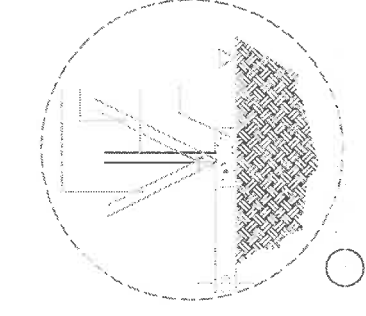
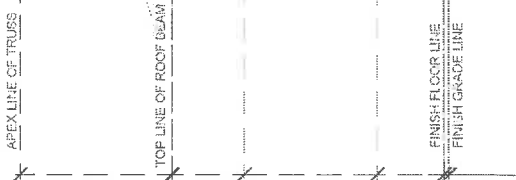
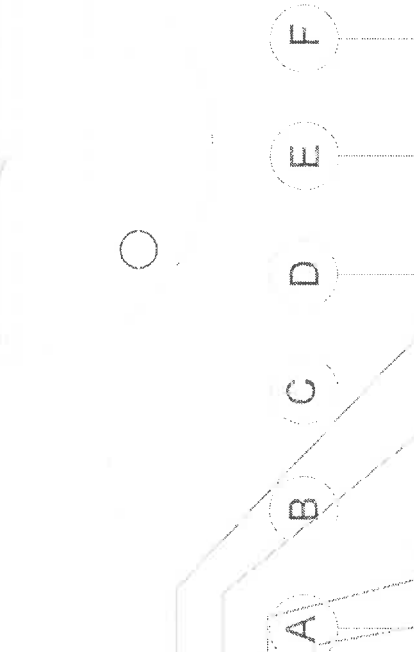
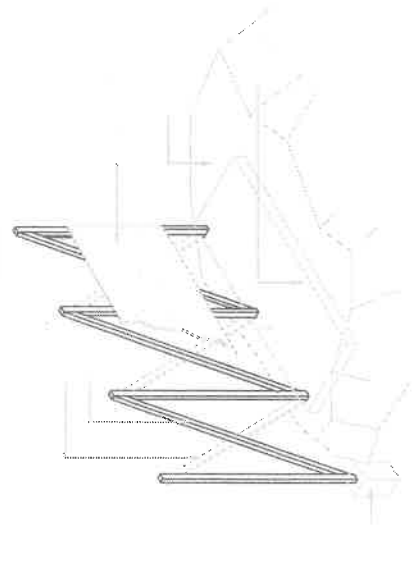
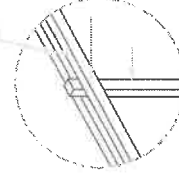
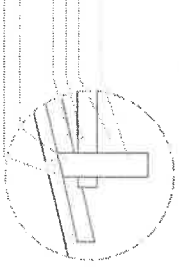

<p>DEPED DIVISION OFFICE - MARIKINA CITY</p>	<p>PROJECT NO. 2023-001</p> <p>PROJECT TITLE PROPOSED TEMPORARY LEARNING SPACE</p>	<p>DESIGNED BY ARMADE E. VERA REGISTERED ARCHITECT</p>	<p>DATE MAY 2023</p>	<p>PROJECT NO. 2023-001</p> <p>PROJECT TITLE PROPOSED TEMPORARY LEARNING SPACE</p>	<p>DESIGNED BY ARMADE E. VERA REGISTERED ARCHITECT</p>	<p>DATE MAY 2023</p>	<p>PROJECT NO. 2023-001</p> <p>PROJECT TITLE PROPOSED TEMPORARY LEARNING SPACE</p>	<p>DESIGNED BY ARMADE E. VERA REGISTERED ARCHITECT</p>	<p>DATE MAY 2023</p>
<p>DEPARTMENT OF EDUCATION Davao</p>		<p>PROJECT NO. 2023-001</p> <p>PROJECT TITLE PROPOSED TEMPORARY LEARNING SPACE</p>		<p>DESIGNED BY ARMADE E. VERA REGISTERED ARCHITECT</p>		<p>DATE MAY 2023</p>		<p>PROJECT NO. 2023-001</p> <p>PROJECT TITLE PROPOSED TEMPORARY LEARNING SPACE</p>	
<p>PROJECT NO. 2023-001</p> <p>PROJECT TITLE PROPOSED TEMPORARY LEARNING SPACE</p>		<p>DESIGNED BY ARMADE E. VERA REGISTERED ARCHITECT</p>		<p>DATE MAY 2023</p>		<p>PROJECT NO. 2023-001</p> <p>PROJECT TITLE PROPOSED TEMPORARY LEARNING SPACE</p>		<p>DESIGNED BY ARMADE E. VERA REGISTERED ARCHITECT</p>	

SCHEDULE OF LOGO COMPONENTS

COMPONENT	SPECIFICATIONS
POST	14mm x 100mm COGO LUMBER
BEAM BRACKER	50mm x 50mm COGO LUMBER
RAFTER TOP CHORD	50mm x 50mm COGO LUMBER
RAFTER DOSE BEAMS	50mm x 50mm COGO LUMBER
PURLINS	50mm x 50mm COGO LUMBER
DIAGONAL WALL STUD	50mm x 50mm COGO LUMBER

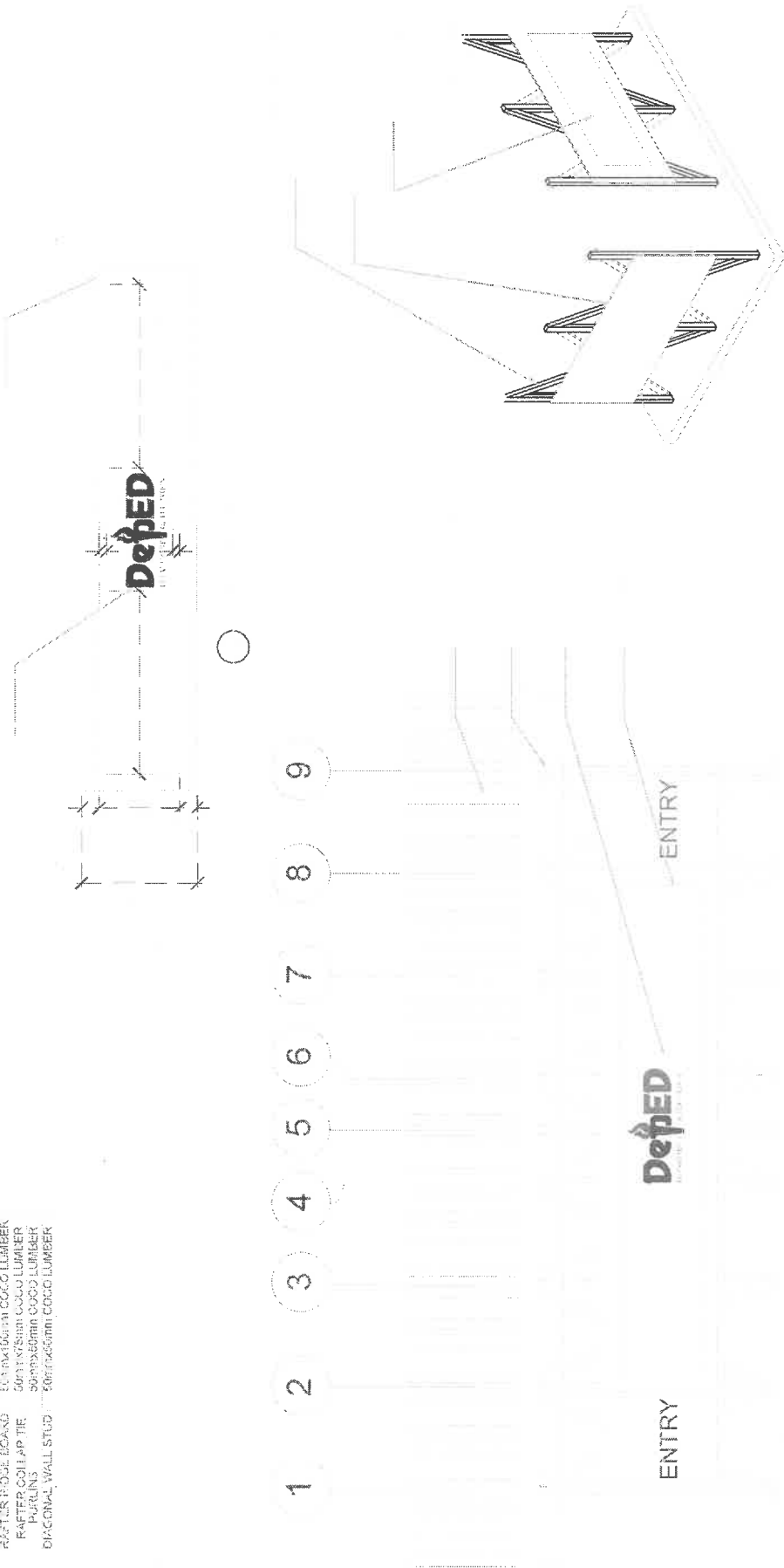

<p>APPROVED BY: </p> <p>ARNEL M. DELA CRUZ DIRECTOR OF REGIONAL OFFICE - CDO</p>	<p>NOTES REF. 1</p> <p>FOR THE PROPOSED TEMPORARY LEARNING SPACE</p>	<p>APPROVED BY: </p> <p>ARNEL M. DELA CRUZ DIRECTOR OF REGIONAL OFFICE - CDO</p>	<p>APPROVED BY: </p> <p>ARNEL M. DELA CRUZ DIRECTOR OF REGIONAL OFFICE - CDO</p>	<p>PROJECT TITLE</p> <p>PROPOSED TEMPORARY LEARNING SPACE</p>	<p>DEPARTMENT OF EDUCATION</p> <p>DepEd</p>	<p>DATE: 08/23/2023</p> <p>PROJECT NO: 2023-08-001</p> <p>PROJECT LOCATION: [REDACTED]</p>
---	--	---	---	---	---	--

NOTE: THIS DRAWING IS THE PROPERTY OF THE ARCHITECT. IT IS TO BE USED ONLY FOR THE PROJECT AND LOCATION SPECIFICALLY MENTIONED HEREIN. ANY REUSE OR MODIFICATION WITHOUT THE ARCHITECT'S WRITTEN PERMISSION IS STRICTLY PROHIBITED.

TABLE OF CONTENTS

ARCHITECTURAL	A-1 PROPOSING NEW FOUNDATION FOR ROOF FINISH FURN FROM EXIST. ROOF FLOOR TO ROOF USE ELEV. CROSS SECTION, LEGENDARY SECTION A-2 A-3 DETAILS FOR ROOF FINISH FURN ROOF SCHEDULE	LINE & GRADE
STRUCTURAL	S-1 FOUNDATION FOR ROOF FINISH FURN 30" TYPICAL, 10'-0" TYPICAL	STRUCTURAL
ELECTRICAL	E-1 LIGHTING FIXTURE LIGHT SCHEDULE GENERAL NOTES, LEGEND ROOF DRAWING	SANITARY
SANITARY	P-1 PLUMBING FIXTURE PLUMBING SCHEDULE GENERAL NOTES, LEGEND CROSS SECTION, LEGENDARY SECTION	ELECTRICAL
		MECHANICAL

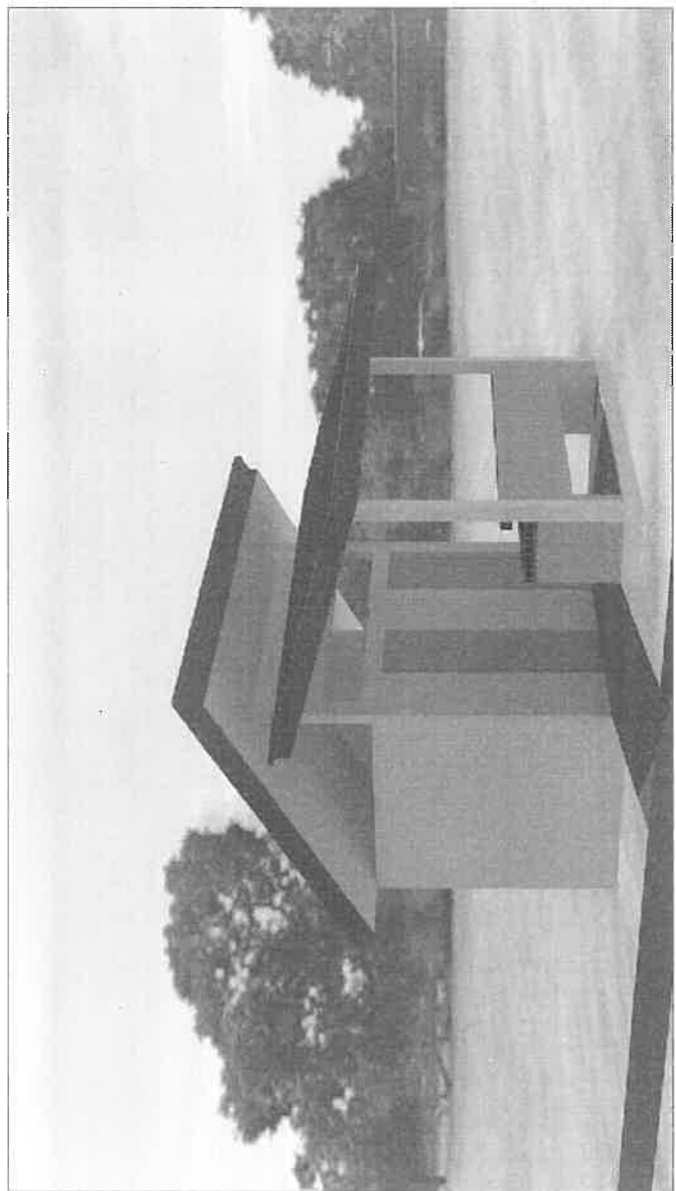

1
A-1
SCALE: 1/8" = 1'-0"

 DEPARTMENT OF EDUCATION DepEd	OWNER:	PROJECT CODE:	PROJECT TITLE:	APPROVED BY:	RECOMMENDING APPROVAL:	CHECKED BY:	DRAWN BY:	SHEET NO:
	DEPARTMENT OF EDUCATION DepEd		TWO SEATER TOILET DETACHED (TYPE I)	OLIVER R. HERNANDEZ CHIEF, PSEB-OPS DEPED	LUIS G. PURISMA, JR. ASST. CHIEF, PSEB-OPS DEPED	NATHANIEL C. MENDOZA ARCHITECT PSEB-OPS	JUNELSON P. CULLADO CIVIL ENGINEER, PSEB-OPS	A-1 3
SHEET CONDITIONS:								RESPECTIVE

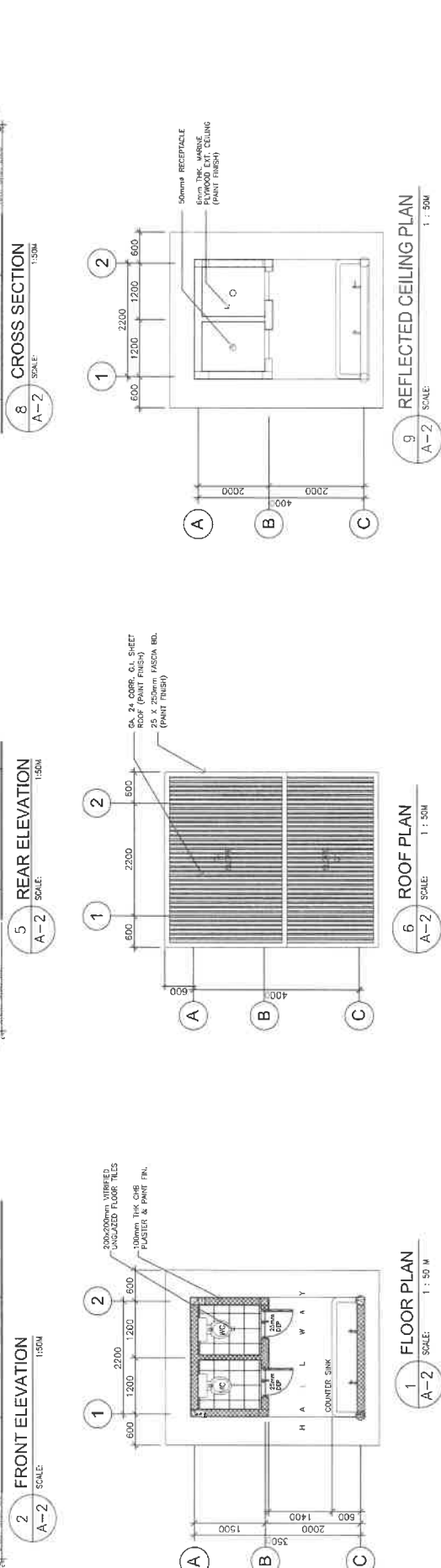
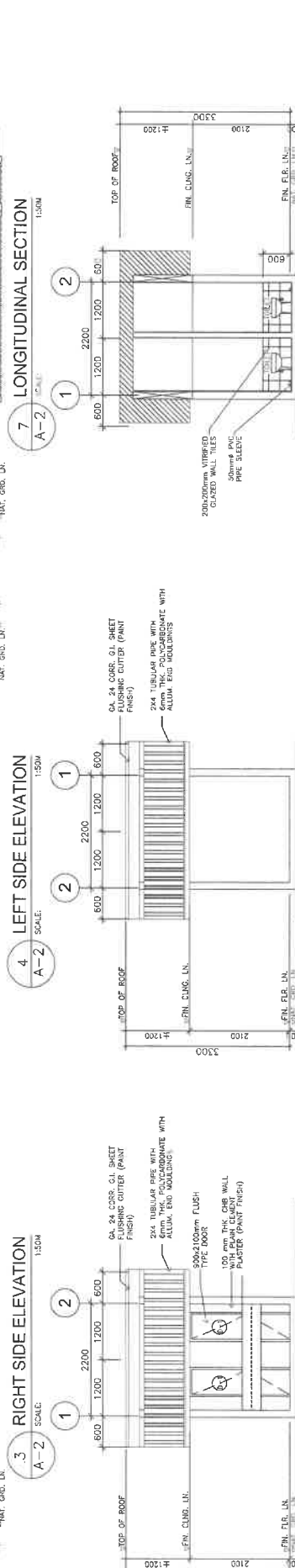
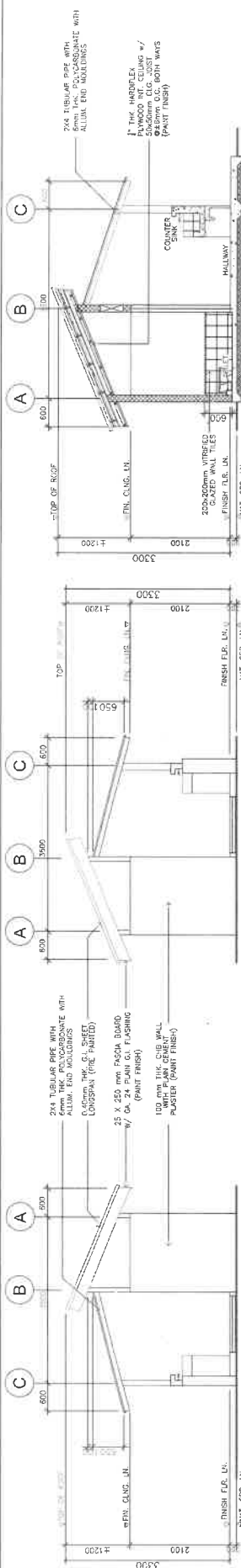

	RECOMMENDING APPROVAL NATHANIEL G. MENDOZA ARCHITECT PRC-REGD	APPROVED BY : LUIS G. PURISIMA, JR. ASST. CHIEF, PRC-OPS DepEd	PROJECT TITLE : TWO SEATER TOILET DETACHED (TYPE I)	PROJECT CODE : DEPARTMENT OF EDUCATION DepEd	SHEET NO. A-2 3
--	---	--	---	---	------------------------------

SANITATION FACILITIES			
GRADE LEVEL	TOILET	TOILET	TOILET
	SLAB HEIGHT	TOILET	TOILET
		HEIGHT	HEIGHT
		TOILET	TOILET
		HEIGHT	HEIGHT
4-5 (KINDERGARTEN-GRADE VI)	260 mm	380 mm	800 mm
4-5 (GRADE IV-GRADE VI)	300 mm	700 mm	1005 mm
7-12 (SECONDARY)	380 mm	780 mm	1035 mm

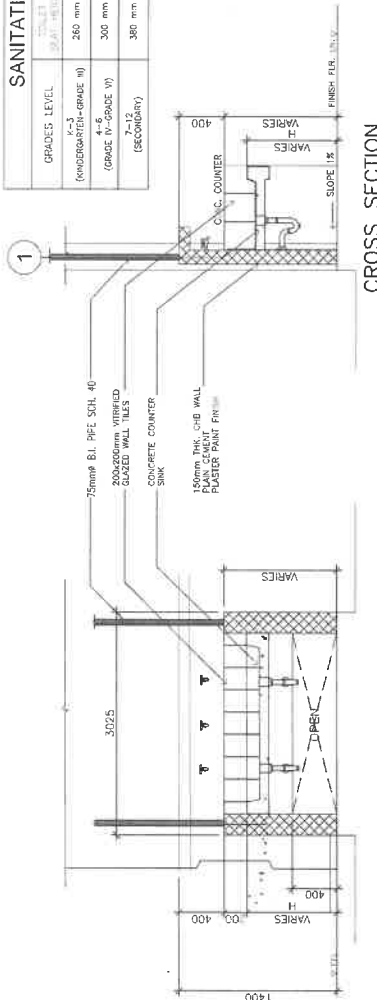

SECTIONAL ELEVATION

CROSS SECTION

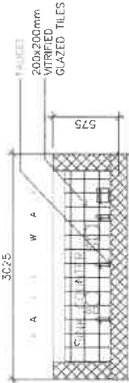

DETAILED PLAN

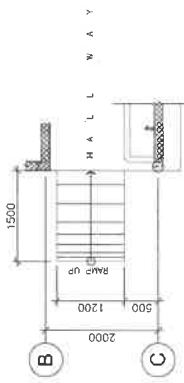

DETAIL PLAN

1 DETAIL OF COUNTER SINK
SCALE: 1:20M

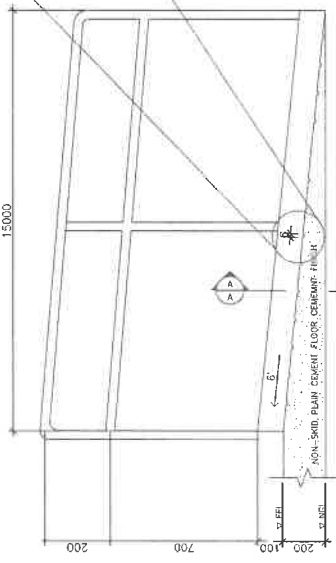
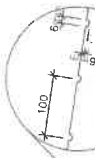

ELEVATION

2 RAMP DETAILS
SCALE 1:20M

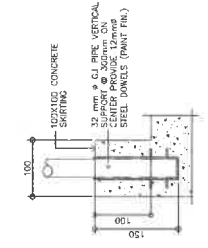

B SPOT DETAIL
SCALE 1:3 M

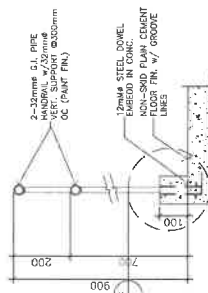

A DETAIL SECTION
SCALE 1:10 M

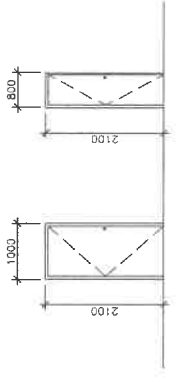

3 SCHEDULE OF DOORS & WINDOWS
SCALE 1:50M

NOTE:
1. HANDRAILS ARE MANDATORY IF THE HEIGHT OF THE HANDRAILS IS MORE THAN 900mm. THE SLOPE OF THE RAMP MUST NOT EXCEED 8% (GENERAL SLOPE IS 5%).
2. PROVISION OF HANDRAILS MUST BE PROVIDED IF THE RAMP IS ABOVE 400mm FROM THE NATURAL GRADE LINE.

<p>REPUBLIC OF THE PHILIPPINES DepEd DIVISION OFFICE - WEST VALLEY MUNICIPALITY OF SANITATION ENGINEERING DIVISION MUNICIPALITY OF SANITATION ENGINEERING DIVISION</p>	<p>DRAMA BY : JUNELSON P. CULLADO LDD OFFICE, PSD-3463</p>	<p>CHECKED BY : MATTHEW G. MENDOZA ARCHITECT PSD-3463</p>	<p>RECOMMENDING APPROVAL LUIS G. PURISMA, JR. ASST. CHIEF PSD-485 Lead</p>	<p>APPROVED BY : OLIVER R. HERNANDEZ CHIEF, PSD-105 Lead</p>	<p>PROJECT TITLE : TWO SEATER TOILET DETACHED (TYPE I)</p>	<p>PROJECT CODE DEPT. OF EDUCATION DepEd</p>	<p>SHEET NO. A-3 3</p>
---	--	---	--	--	--	--	--------------------------------

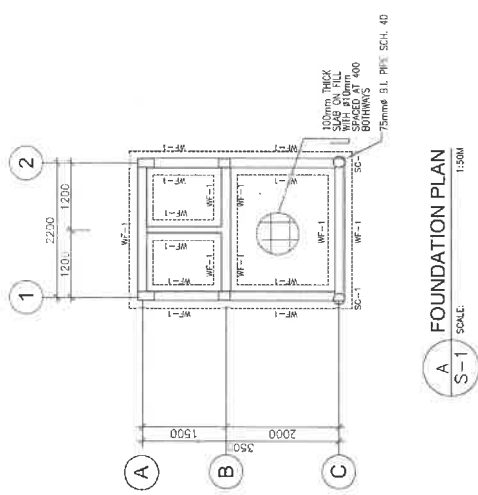

A FOUNDATION PLAN
SCALE: S-1
1:1500

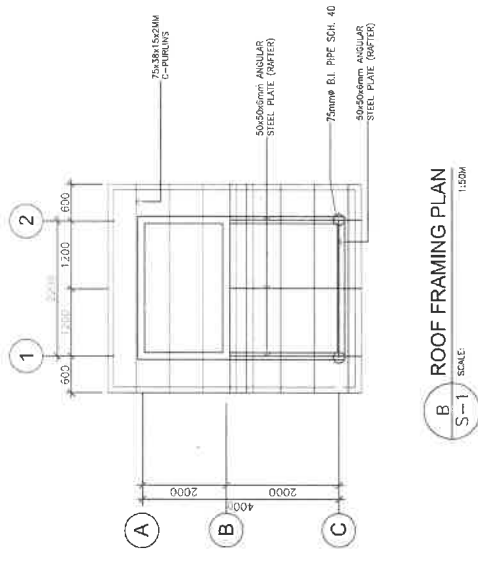

B ROOF FRAMING PLAN
SCALE: S-1
1:1500

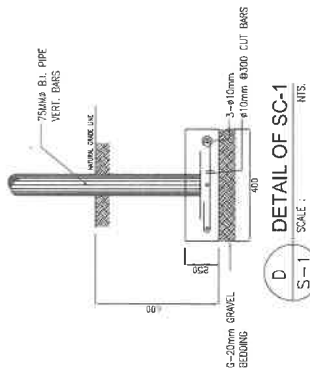

D DETAIL OF SC-1
SCALE: S-1
NTS

C SC-1 DETAIL
SCALE: S-1
NTS

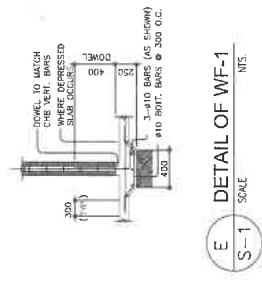

E DETAIL OF WF-1
SCALE: S-1
NTS

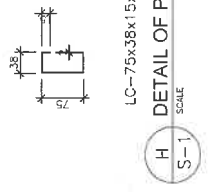

H DETAIL OF PURLINS
SCALE: S-1
NTS

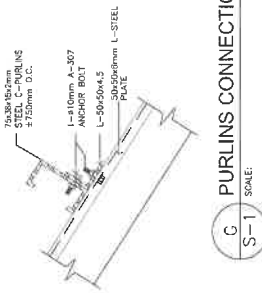

C PURLINS CONNECTION DET.
SCALE: S-1
NTS

	<p>APPROVED BY : JUNIELSON P. CULLADO CIVIL ENGINEER, PRC-0487</p>	<p>APPROVED BY : GARRY CABANILLA STRUCTURAL ENGINEER, PRC-0487</p>	<p>RECOMMENDING APPROVAL : LUIS G. PURISMA, JR. ASST. CIVIL, PRC-0485</p>	<p>APPROVED BY : OMER R. HERNANDEZ CIVIL, PRC-0485</p>	<p>PROJECT CODE :</p>	<p>OWNER : DEPARTMENT OF EDUCATION DepEd</p>	<p>SHEET NO. : S-1 1</p>
	<p>PROJECT TITLE : TWO SEATER TOILET DETACHED (TYPE I)</p>	<p>DATE PREPARED :</p>	<p>SHEET CONTENTS : FOUNDATION PLAN, ROOF FRAMING PLAN, STRUCTURAL PLAN, ELECTRICAL PLAN, MECHANICAL PLAN, AND P&ID.</p>	<p>PROJECT CODE :</p>	<p>OWNER : DEPARTMENT OF EDUCATION DepEd</p>	<p>SHEET NO. : S-1 1</p>	

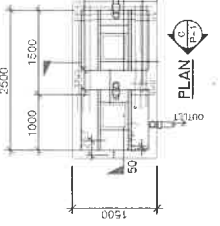

A PLAN DETAILS
SCALE: 1:500

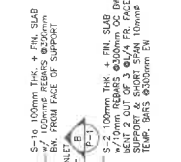

B SECTION DETAILS
SCALE: 1:500

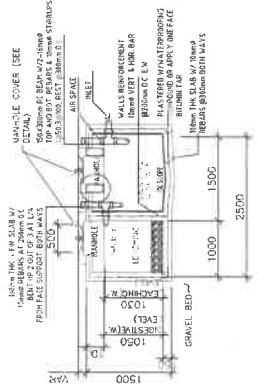

C SECTION DETAILS
SCALE: 1:500

3 SEPTIC TANK DETAILS
SCALE: 1:40

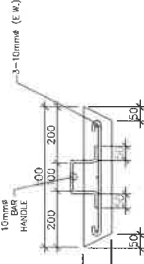

LEGEND

- CB MANHOLE COVER
- CDP CONCRETE DRAIN PIPE
- CO CHECK OUT
- CV CHECK VALVE
- FB FLOOR FINISH
- FD FLOOR DRAIN
- GC GALVANIZED IRON COLD WATER RISER (SCH. 40)
- GV GATE VALVE
- HA MANHOLE
- PCPS POLYVINYL CHLORIDE DOWNSPOUT
- PCPV POLYVINYL CHLORIDE DRAIN PIPE
- PCPS POLYVINYL CHLORIDE DOWNSPUT
- PCPS POLYVINYL CHLORIDE SINK PIPE
- PCPS POLYVINYL CHLORIDE VENT PIPE
- PCPS POLYVINYL CHLORIDE VENT STACK
- PCPVW POLYVINYL CHLORIDE VENT THROUGH ROOF/WALL
- PCPVW POLYVINYL CHLORIDE WASTE PIPE
- PCPVW POLYVINYL CHLORIDE WASTE STACK
- RD ROOF DRAIN
- UD URINAL DRAIN
- WC WALK-IN CLOSET
- WC WALK-IN CLOSET
- CS COUNTER SINK

GENERAL NOTES

1. FINISH OF HORIZONTAL FINISHES: RUN ALL HORIZONTAL FINISHES: 1. PERFECT AT CURBET AND AT A FORM GRADE NOT LESS THAN TWO PERCENT (2%);
2. ALL CHANGE IN DIRECTION SHALL BE MADE BY APPROPRIATE USE OF 45° BENDS. SHIFTS IN THE LINE SHALL BE MADE BY THE USE OF 45° BENDS. SHIFTS IN THE LINE SHALL BE MADE BY THE USE OF 45° BENDS. SHIFTS IN THE LINE SHALL BE MADE BY THE USE OF 45° BENDS.
3. ALL HORIZONTAL FINISHES SHALL BE MADE BY APPROPRIATE USE OF 45° BENDS. SHIFTS IN THE LINE SHALL BE MADE BY THE USE OF 45° BENDS. SHIFTS IN THE LINE SHALL BE MADE BY THE USE OF 45° BENDS.
4. ALL HORIZONTAL FINISHES SHALL BE MADE BY APPROPRIATE USE OF 45° BENDS. SHIFTS IN THE LINE SHALL BE MADE BY THE USE OF 45° BENDS. SHIFTS IN THE LINE SHALL BE MADE BY THE USE OF 45° BENDS.
5. ALL HORIZONTAL FINISHES SHALL BE MADE BY APPROPRIATE USE OF 45° BENDS. SHIFTS IN THE LINE SHALL BE MADE BY THE USE OF 45° BENDS. SHIFTS IN THE LINE SHALL BE MADE BY THE USE OF 45° BENDS.
6. ALL HORIZONTAL FINISHES SHALL BE MADE BY APPROPRIATE USE OF 45° BENDS. SHIFTS IN THE LINE SHALL BE MADE BY THE USE OF 45° BENDS. SHIFTS IN THE LINE SHALL BE MADE BY THE USE OF 45° BENDS.
7. ALL HORIZONTAL FINISHES SHALL BE MADE BY APPROPRIATE USE OF 45° BENDS. SHIFTS IN THE LINE SHALL BE MADE BY THE USE OF 45° BENDS. SHIFTS IN THE LINE SHALL BE MADE BY THE USE OF 45° BENDS.
8. ALL HORIZONTAL FINISHES SHALL BE MADE BY APPROPRIATE USE OF 45° BENDS. SHIFTS IN THE LINE SHALL BE MADE BY THE USE OF 45° BENDS. SHIFTS IN THE LINE SHALL BE MADE BY THE USE OF 45° BENDS.
9. ALL HORIZONTAL FINISHES SHALL BE MADE BY APPROPRIATE USE OF 45° BENDS. SHIFTS IN THE LINE SHALL BE MADE BY THE USE OF 45° BENDS. SHIFTS IN THE LINE SHALL BE MADE BY THE USE OF 45° BENDS.
10. ALL HORIZONTAL FINISHES SHALL BE MADE BY APPROPRIATE USE OF 45° BENDS. SHIFTS IN THE LINE SHALL BE MADE BY THE USE OF 45° BENDS. SHIFTS IN THE LINE SHALL BE MADE BY THE USE OF 45° BENDS.

DESIGN CRITERIA

1. LIVE LOAD
2. ALLOWABLE STRESSES
 - a. FOR FOOTING, BEAMS AND SLABS: $f_c = 20 \text{ MPa}$
 - b. CONCRETE MASONRY UNITS (LOAD BEARING CHB): $f_m = 6.90 \text{ MPa}$, $f_m = 2.41 \text{ MPa}$
 - c. REINFORCING STEEL: $f_y = 230 \text{ MPa}$
 - d. FOR BARS SMALLER THAN 16mm: $f_y = 230 \text{ MPa}$
3. ASSUMED ALLOWABLE BEARING CAPACITY: $Y = 100 \text{ KPa}$

NOTE:

- WATER TABLE IS 1500 BELOW GROUND LEVEL.
- ← SLOPE DIRECTION OF FLOOR DRAIN

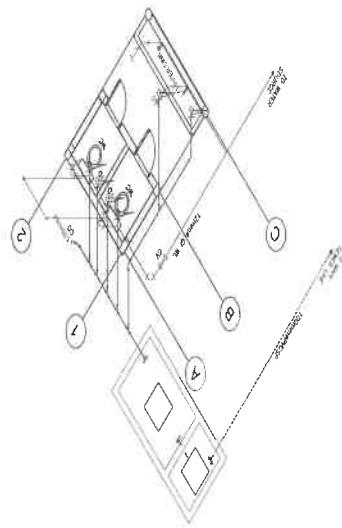

2 ISOMETRIC VIEW
SCALE: 1:500

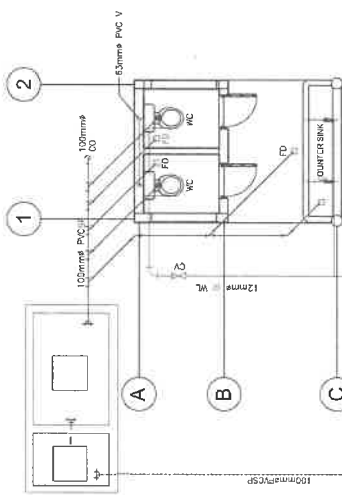

1 PLUMBING RO-IN LAYOUT
SCALE: 1:500

<p>DEPED DIVISION OFFICE - MARIKINA CITY PHYSICAL FACILITIES AND SUPPORT SERVICES DIVISION MARIKINA CITY, PANGASINAN</p>	<p>DRAWN BY: JUNELOO P. CULLAJO CHECKED: DWENESS, FRED-DAVID</p>	<p>DESIGNED BY: CHRISTOPHER J. MANUNG CHECKED: DWENESS, FRED-DAVID</p>	<p>RECOMMENDING APPROVAL: LUIS C. PURISIMA, JR. ASST. CHIEF, PRESD-OPS</p>	<p>APPROVED BY: OLIVER R. HERNANDEZ CHIEF, PRESD-OPS</p>	<p>PROJECT TITLE: TWO SEATER TOILET DETACHED (TYPE I)</p>	<p>OWNER: DEPARTMENT OF EDUCATION DepEd</p>	<p>SHEET NO: P-1 1</p>
--	--	--	--	--	---	---	----------------------------

GENERAL NOTES :

- ALL ELECTRICAL WORK SHALL COMPLY FULLY WITH THE APPLICABLE PROVISIONS, RULES AND REGULATIONS OF THE PHILIPPINE ELECTRICAL CODE (PEC) OF THE LATEST EDITION OF THE PHILIPPINE ELECTRICAL CODE (PEC) AND THE REQUIREMENTS OF THE LOCAL ENFORCING AUTHORITY AND THE REQUIREMENTS OF THE LOCAL POWER COMPANY. THE ELECTRICAL WORKS SHALL BE UNDER IMMEDIATE SUPERVISION OF A DULY REGISTERED ELECTRICAL ENGINEER.
- THE ELECTRICAL SERVICE POWER IS 1-PHASE, 3-WIRE + GROUND 230 V AC, 60 HZ.
- WIRING METHOD SHALL BE AS FOLLOWS :
 a. FEEDERS AND RISERS — INTERMEDIATE METALLIC CONDUIT
 b. LIGHTING, POWER RECEPTACLE — POLYVINYL CHLORIDE CONDUIT
 c. BRANCH CKT. & AUXILIARY — THICK WALL
- ALL WIRES SHALL BE COPPER AND THERMOPLASTIC INSULATED TYPE "THINN" UNLESS OTHERWISE INDICATED IN THE PLAN. THE MINIMUM SIZE OF WIRE FOR POWER AND LIGHTING CIRCUIT HOMERUN SHALL BE 1.5mm² AND INSULATED FOR 600 VOLT. SMALLEST RACEWAY SHALL BE 15mm² TRADE/NOMINAL SIZE.
- ALL OUTLET BOXES SHALL BE GALVANIZED GAGE NO. 16 DEEP TYPE WITH FACTORY KNOCKOUTS.
- ALL MATERIALS TO BE USED SHALL BE BRAND NEW AND APPROVED TYPE FOR THE PARTICULAR LOCATION AND PURPOSE OF USAGE.
- EQUIPMENT GROUNDING SYSTEM SHALL BE PROVIDED TO THE ELECTRICAL SYSTEM AS PER PHILIPPINE ELECTRICAL CODE REQUIREMENT.
- MOUNTING HEIGHT OF WIRING DEVICES SHALL BE AS FOLLOWS :
 a. LIGHT SWITCH — 1.30 M ABOVE FINISH FLOOR
 b. CONVENIENCE OUTLET — 0.30 M ABOVE FINISH FLOOR
 c. PANELBOARD — 1.50 M ABOVE FINISH FLOOR
 d. FIRE ALARM STATION OUTLET — 1.50 M ABOVE FINISH FLOOR
 e. PUSH BUTTON OUTLET — 1.20 M ABOVE FINISH FLOOR
 f. FIRE ALARM & VIBRATING BELL — 0.30 M BELOW CEILING LINE

2 LOAD COMPUTATION

LIGHTING OUTLET = 3 x 20 WATTS = 60 WATTS
 VA LOAD = 60 X 1.25 = 75VA
 IL = $\frac{75 \text{ VA}}{230 \text{ V}}$ = 0.33 AMPERES

FEEDER 2 - 3.5mm² THHN + 1 - 3.5 mm² THHN (S) IN 20mm Ø RSC
 PROTECTION 1 - 20A 2P, 230V, BOLT-ON SAFETY BREAKER WITH ABS ENCLOSURE

3 SINGLE LINE DIAGRAM

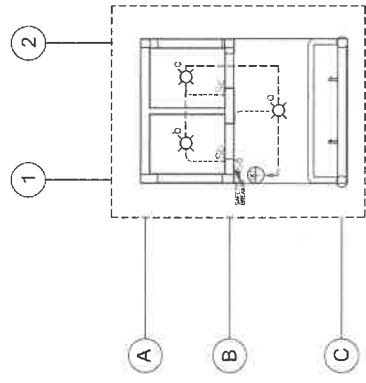
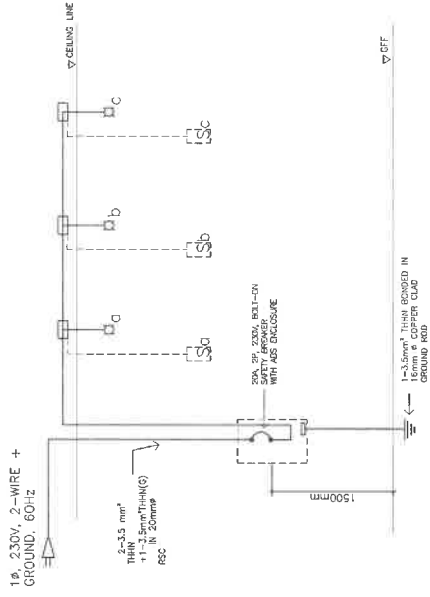

LEGEND :

- | SYMBOL | DESCRIPTION |
|--------|--|
| ◇ | CEILING LIGHT OUTLET |
| □ | 1 x 40 WATTS FLUORESCENT LAMP |
| Sa | ONE GANG DEVICE SWITCH |
| Sob | TWO GANG DEVICE SWITCH |
| Soc | THREE GANG DEVICE SWITCH |
| --- | RACEWAY CONDUIT CONCEALED IN CEILING |
| ⎓ | PANELBOARD, MARKED AS "LP" |
| ⎓ | GKT, BREAKER, RATING AS INDICATED |
| ⊕ | TAMPARED PROOF DUPLEX CONVENIENCE OUTLET, MODERN TYPE, 16 AMPS, 250 VOLT WITH MODERN PLATE COVER |
| ⊕ | CIRCUIT HOMERUN |
| ⊕ | SERVICE ENTRANCE |

REPUBLIC OF THE PHILIPPINES DepEd DEPARTMENT OF EDUCATION DIVISION OFFICE - CAGAYAN DE ORO MUNICIPAL ENGINEERING DIVISION MUNICIPAL ENGINEER, CAGAYAN DE ORO	DRAWN BY : CRISAN P. CORONEL ENGINEER REGD-0460	CHECKED BY : CEASAR S. BRAVO PROFESSIONAL ELECTRICAL ENGINEER REGD-0600	RECOMMENDING APPROVAL LUIS G. PURISMA, JR. ASST. DIR. / REGD-045 CHIEF	APPROVED BY : OLIVER R. HERMANDEZ CHIEF, REGD-045 DEPT	PRODUCT TITLE : TWO SEATER TOILET DETACHED (TYPE I)	PROJECT CODE : DEPARTMENT OF EDUCATION DepEd SHED CODE : LIGHTING LAYOUT LOAD SCHEDULE GENERAL NOTES LEGEND, RISER DIAGRAM	SHEET NO. E-1 1
	DATE PREPARED :						

PROGRAM SUPPORT FUNDS TO FIELD OFFICES ON
DISASTER PREPAREDNESS AND RESPONSE PROGRAM
Frequently Asks Questions

1. What is Disaster Preparedness and Response Program?

The Department of Education-Disaster Prepared and Response Program (DPRP) funds under the General Appropriations Act (GAA) is used for preparedness, prevention and mitigation and response, rehabilitation and recovery programs for the public education sector.

2. Why there is a 2B additional funds for DPRP?

The 2023 National Expenditure Program Allocates PhP 129,453,000.00 for DPRP funds is insufficient.

Majority of the DPRP funds are used to implement response and early recovery programs, particularly the construction of Temporary Learning Spaces (TLS), Clean-up and minor repairs, provision of learners' and teachers' kits, and hygiene kits. Faced with budgetary constraints, addressing infrastructure damage through TLS construction is prioritized over other forms of assistance such as teachers' and learners' kits. Given this, additional funds is needed to cover the replacement of damaged items.

As such, the Department of Education requests additional funds to fully fund regular programs, projects, and activities on preparedness, prevention and mitigation, and response, rehabilitation and recovery.

The proposal supports DepEd's continuing commitment to provide a conducive teaching and learning environment for teachers and learners.

3. What are the component of Disaster Preparedness?

The component of Disaster Preparedness are:

- a. Implementation of Disaster Risk Reduction and Management (DRRM) Programs, Projects and Activities (PPAs)
- b. Contingency Plan
- c. Public Service Continuity Plan
- d. Procurement of Emergency Supplies and Equipment

This component supports the implementation of Disaster Preparedness-related PPAs that the field offices identified and reflected in the approved Expenditure Matrix and Work and Financial Plan.

4. What are the component of Disaster Response?

The component of Disaster Response are:

- a. Provision of Funds for Temporary Learning Spaces
- b. Provision of Funds for Clean-up and Minor Repair
- c. Provision of Funds Response Mobilization
- d. Provision of Funds for Temporary WASH Facility
- e. Provision of Funds for Psychological First Aid

The Regional allocation for the Disaster Response shall serve as the Regional Standby Funds and shall only be provided to the SDOs during the declaration of State of Calamity, or State of Emergency by the Local Government Units (LGUs) or National Government, or other disaster-related declaration (whether naturally occurring or human-induced) that are deemed necessary. On the other hand, when there is no State of Calamity or State of Emergency, and there is a need to use the standby fund, there should be an authority to request the utilization of the fund.

5. What are the basis of computation for Regional Allocation?

The main consideration in coming up to the Regional allocation is the Frequency of hazards and/or emergencies that the regions, divisions and schools experienced in the last 10 years based on the data captured at the enhanced Basic Education Information System (BEIS) and the rate of DPRP Utilization downloaded to regions in the previous years

6. What is the manner of Reporting?

To monitor the progress of the implementation of the Disaster Preparedness-related PPAs and Response Interventions, implementing units are required to submit a monthly report to the DRRMS at drmmo@deped.gov.ph on or before the end of the month. These reports should include information on the accomplishments, obligations, liquidation status, and photo documentation of the utilization of the DPRP.

7. Is there a possibility to realign the fund allocation to other purposes?

The approved **Two Billion Pesos** (Php 2,000,000,000.00) of the FY 2023 Disaster Preparedness and Response Program funds will be used for the implementation of Disaster Preparedness-related PPAs and Response Interventions for field offices.

The realignment of funds shall be allowed provided that it will not defeat its purpose, concerned division offices may request the realignment of funds addressed to the Undersecretary for Finance and Undersecretary for Operations through the Office of the Director IV, Disaster Risk Reduction and Management Service.

To request the realignment, the following document should be submitted:

- a. A written narrative stating the reason for realignment signed by the concerned Schools Division Superintendent.
- b. A written documentation from the original school signed by the School Head stating the reason for the realignment of funds.
- c. The request for realignment of funds and change of recipient school/s must be submitted to the DRRMS for review and endorsement to the Office of the Director IV, Finance Service for further review and approval of the Undersecretaries for Finance and Operations

It is important to note that these funds should not be used for any Climate Change Adaptation and Mitigation (CCAM) and other PPAs unless otherwise indicated in a supplemental memorandum aligned with this Implementing Guidelines

8. What will happen to the downloaded fund to regions if this will not be utilized in a given time?

The FY 2023 DPRP funds appropriations will remain valid until December 31, 2024.

In cases where no disaster occurs in the Regions toward the end of 4th quarter of the current Fiscal Year, the DepEd Central Office may withdraw the standby fund and download it to the Regional Offices that need it most

Suggested Content of Safety and Emergency Supplies and Equipment:

No.	Item	Quantity	Unit of Measure	Unit Cost	Total Cost
1	Portable Public Address system	pc	1	11,500.00	11,500.00
2	Trauma Bag with contents for 20 - 25 persons	pc	2	15,000.00	30,000.00
3	Fire Extinguisher	pc	2	1,300.00	2,600.00
4	Fire Cabinet and Fire Hose	pc	2	7,800.00	15,600.00
5	Power Sprayer	pc	2	16,000.00	32,000.00
6	Traffic Vest	pc	10	500.00	5000.00
Total					96,700.00

Suggested Content of Go Bag

No.	Item	Quantity	Unit of Measure	Estimated Unit Cost	Estimated Total Cost
1	Drawstring Backpack	1	Piece	100.00	100.00
2	Hard Hat	1	Piece	350.00	350.00
3	Mini Flashlight	1	Piece	125.00	125.00
4	Whistle	1	Piece	25.00	25.00
5	Emergency Infographics (local maps, hotlines, survival tips, evacuation route)	1	Set	100.00	100.00
6	Raincoat	1	Piece	100.00	100.00
7	Water Bottle	1	Piece	100.00	100.00
8	Age-appropriate First Aid Kit (band-aid, alcohol pad, gauze pad, clinic tape, povidone-iodine prep pad)	1	Set	100.00	100.00

Suggested Content of Teachers Kit:

No.	Item	Quantity	Unit of Measure	Estimated Unit Cost	Estimated Total Cost
1	Plastic utility/ storage box	1	Piece	400.00	400.00
2	Bond paper (A4 size)	3	Ream	350.00	1,050.00
3	Bond paper (legal size)	2	Ream	380.00	760.00
4	Colored paper (A4 size)	1	Ream	200.00	200.00
5	Expandable brown envelope (long, w/o handle)	5	Piece	18.00	90.00
6	Expandable plastic envelope (long, w/o handle)	5	Piece	14.00	70.00
7	Folder (long)	10	Piece	6.00	60.00
8	Class record (big)	1	Piece	50.00	50.00
9	Masking tape (1")	5	Roll	34.00	170.00
10	Stapler (No. 35)	1	Piece	230.00	230.00
11	Staple wire (No. 35, 5000s)	3	Box	60.00	180.00
12	Whiteboard (size: 36 x 18 inches)	1	Piece	800.00	800.00
13	Whiteboard Eraser	1	Piece	30.00	30.00
14	Whiteboard Marker (1 pc per color: black, blue, red)	3	Piece	50.00	150.00
15	Musical instrument for PFA (e.g., maracas, tambourine, ukulele)	1	Piece	500.00	500.00
16	Stress ball, 7cm diameter	1	Piece	50.00	50.00
17	Printer Ink (suitable to available school printer)	4	Bottle	300.00	1,200.00
18	Flash Drive (32 GB)	1	Piece	200.00	200.00
19	Whistle	1	Piece	70.00	70.00
20	Flashlight	1	Piece	200.00	200.00
21	Raincoat	1	Piece	150.00	150.00
22	Surgical Mask	2	Box	70.00	140.00
23	Alcohol (500 ml)	2	Bottle	100.00	200.00
24	Hand Soap	1	Piece	50.00	50.00
GRAND TOTAL					7,000.00

Suggested Content of Learners Kit

No.	Item	Quantity	Unit of Measure	Estimated Unit Cost	Estimated Total Cost
1	Notebook, no spring, 80 leaves	10	Piece	18.00	180.00
2	Pad paper	2	Piece	20.00	40.00
3	Ruler	1	Piece	10.00	10.00
4	Rubber Eraser	1	Piece	10.00	10.00
5	Pencil Sharpener	1	Piece	20.00	20.00
6	Transparent plastic envelope	1	Piece	10.00	10.00
7	Glue stick	1	Piece	10.00	10.00
8	Ballpens (red, blue, black)	3	Piece	18.00	54.00
9	Pencil case	1	Piece	50.00	50.00
10	Pencils	3	Piece	10.00	30.00
11	Crayons (12 colors)	1	box	30.00	30.00
12	Backpack	1	Piece	400.00	400.00
13	Scissors	1	Piece	23.00	23.00
14	Raincoat	1	Piece	230.00	230.00
15	Surgical Mask	2	Box	50.00	100.00
16	Alcohol	1	Bottle	50.00	50.00
17	Hand Soap	1	Piece	35.00	35.00
18	Whistle	1	Piece	20.00	20.00
19	Flashlight	1	Piece	120.00	120.00
20	Face Towel	1	Piece	30.00	30.00
21	Toothbrush	1	Piece	18.00	18.00
22	Toothpaste (100ml)	1	Piece	30.00	30.00
23	Shampoo	1	Bottle	50.00	50.00
24	Stress ball, 7cm diameter	1	Piece	50.00	50.00
25	Stuff toy or story books	1	Piece	100.00	100.00
GRAND TOTAL					1,700.00

Suggested Content of the Play kit for Psychological First Aid

No.	Item	Quantity	Unit of Measure	Estimated Unit Cost	Estimated Total Cost
1	Stress ball, 7cm diameter	10	Piece	50.00	500.00
2	Ready Kid Stuffed Toy or Storybook for Elementary; Coloring Book for Secondary		Piece	--	500.00
3	Puzzle	5	Piece	200.00	1,000.00
4	Musical instrument	2	Piece	1,000.00	2,000.00
5	Emotion Cards	1	Set	200.00	200.00
6	Fidget Toys (for SPED learners)	10	Piece	30.00	300.00
7	Board Game	2	Piece	500.00	1,000.00
8	Plastic container	1	Box	500.00	500.00
GRAND TOTAL					6,000.00

Suggested Content of the First Aid Kit:

No.	Item	Quantity	Unit of Measure	Estimated Unit Cost	Estimated Total Cost
1	Gauze Roll (4inch x 10m)	1	roll	150.00	Php 150.00
2	Gauze Pad (100 pcs)	1	pack	140.00	Php 140.00
3	Elastic Bandage	2	roll	42.00	Php 84.00
4	Emergency Blanket	1	pc	195.00	Php 195.00
5	Antiseptic Wipes	1	pack	79.00	Php 79.00
6	Bandages	1	pack	77	Php 77.00
7	Adhesive Tape	2	rolls	29	Php 58.00
8	Thermometer	1	pc	59	Php 59.00
9	Safety Pins for Arm Sling (10 pcs) with 5 pcs Triangular Bandage	1	set	405	Php 405.00
10	Gloves	1	Box	115	Php 115.00
11	Scissors	2	Pairs	50	Php 100.00
12	Tweezers	2	pcs	34	Php 68.00
13	First Aid Manual	1	book	350	Php 350.00
14	Emergency Contact Information	1			
GRAND TOTAL					Php 1,880.00